

# THE 14<sup>TH</sup> FUNAKOSHI GICHIN CUP WORLD KARATE-DO CHAMPIONSHIPS

AUGUST 18<sup>TH</sup> 19<sup>TH</sup> 20<sup>TH</sup> UL SPORT ARENA

第十四回 船越義珍杯  
2017年 世界空手道選手権  
8月18、19、20日 ULスポーツアリーナ  
アイルランド リムリック大学





# JKA WORLD CHAMPIONSHIPS

17-20 AUGUST 2017



公益社団法人  
日本空手協会



公益社団法人  
日本空手協会  
JKA IRELAND



Celebrating  
Japan Ireland



Fáilte Ireland  
National Tourism Development Authority



## Noel Casey



### Welcome to Ireland

I'd like to personally welcome each of you to the 14th Funakoshi Gichin Cup, world Karate Do Championships. It's an exciting time for JKA Ireland as we continue to grow and be motivated. The world of JKA Shotokan Karate is an exciting area in which to train and compete, Competition brings inspired people from all around the world together to enjoy excellent Karate and meet other karate students with similar values. The 14th Funakoshi Gichin Cup highlights the true spirit of Shotokan Karate and the dedication and expertise of JKA students.

I'd like to give you an idea of what you can expect and what I hope you enjoy over the coming week, The University of Limerick welcomes you to this lovely campus, over the course of the week, you will find time to enjoy all the campus has to offer, social areas and swimming pool, we have a farmers market Thursday morning supplying fresh produce, giving you a taste of Ireland, restaurants and sports facilities in abundance. Take a walk along the living bridge and

cross the river Shannon; hopefully you will get the opportunity to visit Limerick City, only 4 km away, King Johns Castle in Limerick city is one of the best preserved Norman Castles in Europe, and was built in the year 1200.

As Chief instructor of JKA Ireland, I speak on behalf of all JKA Ireland students, we are honoured to host these world championships in Ireland, we thank JKA Japan for putting their trust in JKA Ireland to achieve the standard the world cup deserves. I hope we do not disappoint, and you all enjoy these highly anticipated championships, Good luck in your chosen event, and enjoy your time in Ireland, you are very welcome.

OSS  
Noel Casey  
Chief instructor  
JKA Ireland

# JKA World Championships 17 - 20 August

## CONTENTS

Welcome From The Chairman .....	1
Ambassador of Ireland.....	3
Ambassador of Japan to Ireland.....	4
Masters.....	6
Awardee of Distinguished Devotion Japan.....	12
HQ Instructors.....	13
Programme at a glance.....	20
Junior Championships Schedule.....	21
Senior Championships Schedule.....	22
Senior Championships Finals Schedule .....	23
Participant List.....	26
Draws.....	41

## Mr. Katshide Kusahara

Tournament President  
Chairman of the JKA



On behalf of the Japan Karate Association and JKA World Federation, it is a great pleasure for me to extend my warmest welcome to all participants in the 14th Funakoshi Gichin Cup World Karate-do Championship in Ireland.

This event could not have taken place without the dedication and hard work of the JKA Ireland, to whom I wish to express our heart-felt appreciation. I would also like to thank the Embassy of Japan in Ireland for recognizing this event as part of the official programs to commemorate the 60th anniversary of Japan-Ireland diplomatic relations.

The World Karate-do Championship in memory of Great Master Funakoshi Gichin, the father of modern karate, was first organized in Tokyo in 1985.

Master Funakoshi introduced Okinawan karate-jutsu to the mainland Japan for the first time at the Ministry of Education's First Physical Education Exhibition in 1922 and began teaching it in Tokyo to high school and university students. Being an educator by profession, he valued not only the physical but also the spiritual aspects of karate, believing that karate could be an ideal means to develop one's personality.

In 1948, former students of his Shotokan dojo formed the Japan Karate Association with Funakoshi Gichin as Supreme Master. The JKA eventually developed a system of competitive karate match, which paved the way for the first National Karate-do Championship in 1957.

Today, many karate tournaments are held by many different organizations proclaiming different philosophies and styles of karate. However, we at the JKA are maintaining the original style of 'ippon-shobu' based on 'kime', or a single decisive blow, which is considered an essential element of Japanese 'budo'.

The major purpose of this tournament is not for the participants just to compete to win the match. It is intended rather to serve as an opportunity where all participants can demonstrate their best techniques resulting from many years of hard training, exchange their skills and experiences, and cultivate friendships with their fellow JKA karate-do followers from all around the world.

I hope this event will benefit all participants in achieving objectives in their lifelong pursuit of the way of karate, the ultimate goal of which is to serve as a path to self-perfection, and I wish you all the great success.



公益社団法人  
日本空手協会

## Ueki Masaaki

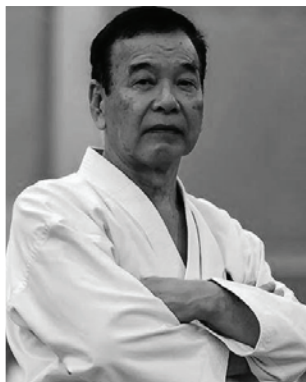

We are so pleased that Funakoshi Gichin Cup the 14th World Karate-do Championship is held in Ireland with many Karate players who have trained hard from all over the world.

We Japan Karate Association pursue "Kime" as the ultimate essence of Karate-do. It is very important to acquire and achieve self-control ability through training of "Kime", which control your maximum power as you intend.

I would like request you players to follow the rule both in Kumite and Kata, respect the opponent, fight fairly with dignified attitude, do your best, and perform wonderful Karate techniques as much as possible. You are also requested to learn "calm mind" at the match as well as the techniques, and acquire fairness, courage, decision making, friendship, politeness and so on.

I do hope you players would fight with the spirit of martial arts, do your best and make good friendship with the fellow players who follow the same way.

Best wishes to you all.

Shuseki Shihan

Ueki Masaaki

世界各国で空手道に精励している多数の選手諸君を迎え、ここに船越義珍杯第 14 回世界空 手道選手権大会がアイルランドにて開催されますこと誠に喜ばしいことであります。

日本空手協会は空手道の原原本質を「極」に求めています。最大限の衝撃力を意のまま に発揮できるよう技を極める鍛錬を通して、自己制御能力を高め、身につけることが肝要 です。

選手諸君には、組手においても形においても規約を守り、相手を尊重し、正々堂々と立派 な態度で試合に臨み、自己の最善を尽くし、空手の立派な極技を存分に発揮し、試合での 技術のみを学ぶのでなく勝負に臨む(平常心)を養い、公正、勇気、決断、友愛、礼儀などを学び身につけて下さい。

この大会に出場する選手諸君は武道精神にのっとり健闘されると共に志を同じくする者同 志友情の輪を広げることを祈念します。

ご健闘を祈ります。



AMBASÁID NA hÉIREANN

AMBASSADE D'IRLANDE                      EMBASSY OF IRELAND

Ireland House, 2-10-7 Kojimachi, Chiyoda-ku, Tokyo 102-0083

Telephone: (03) 3263-0695

The Ambassador

12 April 2017

Mr. Noel Casey  
Chief Instructor  
JKA Ireland

Dear Noel,

Congratulations on your successful bid to host the JKA World Championships from 17 to 20 August, 2017. And best of luck in Limerick to all the participants from around the world.

It is a particular honour that Ireland will host these Championships in 2017 which marks the 60<sup>th</sup> Anniversary of Diplomatic Relations between our country and Japan.

With every best wish for a great success!

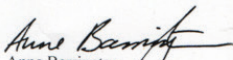
  
Anne Barrington  
Ambassador of Ireland

## Mrs Mari Miyoshi

Ambassador of Japan to Ireland



I am absolutely delighted that this year Ireland has been chosen to host the 14th Funakoshi Gichin Cup World Karate-do Championship. I would like to extend my sincerest thanks to the hard work of JKA Ireland, whose dedication and determination has helped to make this event a success.

In 2017 we celebrate the 60th Anniversary of the establishment of diplomatic relations between Japan and Ireland. Japan and Ireland's relationship is built on the shared values of freedom, democracy, respect for human rights, and the rule of law. Furthermore, we have seen this relationship flourish in the fields of science, literature, business and, of course, sport.

Sport has always been a very strong connection between Japan and Ireland. There are many lovers of Japanese martial arts such as karate, judo, aikido and kendo in Ireland. This Karate Championship has brought people from all over the world to come together, and share their love of Japanese martial arts. This is the kind of cross cultural exchange that forms the very basis of long lasting relationships between countries, not only Japan and Ireland, but every country represented here today. It is also a wonderful chance to display your skills, developed over the years through hard work and dedication.

This strong sports relationship between Japan and Ireland will continue into the future, with Japan hosting the Rugby World Cup in 2019 and Tokyo hosting the 2020 Olympic and Paralympic Games where karate will make its first ever appearance as an Olympic Sport. I hope that you will all have a chance to visit Japan for one of these events, and meet the new friends you have made at this Championship.

Best of luck to all participants from all over the world. Or as we say in Japan, "gambatte kudasai".







## JKA Labels and Emblem



## TOP REASONS TO ORDER



**High quality Hirota**  
belts and gis



**Very competitive price**  
customised orders or  
from Ichiban stock



**Personal double check orders**  
prior to sending them to Hirota and  
before despatching them to you



**Individual service**  
to help you with your order  
throughout its process



**Order delivered as quick**  
as possible from Japan



**Special Next Day Delivery**  
to all UK customers



**DHL express service**  
for our world-wide customers



**PayPal and all major**  
**credit cards accepted**



**Gift cards exchangeable**  
against any products



**Reward points**  
earn as you shop, then  
exchange them for discounts



**Pronunciation line** to ensure correct translation of names.  
Names to be embroidered are translated in **Kanji** or **Katakana**  
by **our native Japanese translator**.

## Master Funakoshi

The Father of Modern Karate



Funakoshi Gichin was born on Nov 10, 1868 in Yamakawa, Shuri, Okinawa Prefecture. He was of samurai lineage, from a family which in former times had been vassals of Ryukyu Dynasty nobles.

By age 11 he had already made a name for himself in Ryukyu-style martial arts. Beginning his training under Master Azato Anko, it wasn't long before he equaled his master in ability, and shared with him the distinction of being the "most accomplished" martial artist in the field. He also learned karate-jutsu (written with characters that mean "Chinese-hand martial art") from Master Itosu Anko. Both his teachers were impressed by his nobility of character.

As over the years he pursued his training and continuously developed his remarkable skills, Master Funakoshi became chairman of the Okinawa Martial Arts Society, as well as an instructor at the Okinawa Teacher's School. Then in 1922, when he was 54 years old, he introduced Okinawan karate-jutsu at the first Ministry of Education (now Ministry of Education, Science, Sports, and Culture)-sponsored Physical Education Exhibition. This introduction, the first ever public display of karate-jutsu in Japan, was a stunning success. And the previously unknown martial artist Funakoshi Gichin rose to instant fame throughout the Japanese world of martial arts.

Immediately the founder of modern judo, Kano Jigoro, invited Master Funakoshi and his pupil Gima Shinkin to the Kodokan judo dojo to give a demonstration of kata. The highly-attended event filled the Kodokan dojo to capacity. It was so well-received that Master Funakoshi found himself pressed on all sides to stay in Tokyo.

Excited by the opportunity to further promote the martial art that he had done so much to introduce to Japan, Master Funakoshi subsequently began teaching it at Tokyo's Meiseijuku, a dormitory for Okinawan students there. In 1922, he published a book entitled "Ryukyu Kempo Karate." It was the first formal exposition in Japan on the art of karate-jutsu. Not only were its contents fresh and novel, it was also beautifully written, and immediately created an unprecedented karate boom.

As the popularity of karate-jutsu began to spread, Master Funakoshi produced the first ever "Dan Ranking Certification" in April, 1924.

Around the same time, with the encouragement of his teacher of Buddhism, Abbot Furukawa Gyodo of Enkakuji Temple in Kamakura, Master Funakoshi started practicing Zen. He contemplated the well-known Buddhist teaching that says "form is emptiness and emptiness is form." He began to see the relevance of that teaching to his martial art, and ultimately changed the characters for karate from kara + te ("Chinese" + "hand") to kara + te ("empty" + "hand").

Then, in order to popularize the "local" Okinawan martial art in the rest of Japan, Master Funakoshi synthesized a complete system of techniques and theory, and changed the Chinese and Okinawan names of the kata into standard Japanese. In 1929, after much thought and reflection, he also changed the name of karate-jutsu ("Chinese-hand martial art") to karate-do ("the way of karate," or "the way of the empty hand"). He then defined the Twenty Precepts of Karate, and established a grand karate philosophy.

At last the way of karate had come into its own, and was gaining popularity all across Japan. The number of people wishing to begin training was growing daily—so much so that it became difficult to find a place for them to practice. So in 1939 Master Funakoshi established the "Shotokan" dojo, which he built at his own expense. ("Shoto" was the literary first name he used when doing calligraphy and writing poetry. "Shoto" means "Pine Waves," and refers to the sound of wind blowing through the pines, which resembles the sound of ocean waves.)

By this time, Master Funakoshi had long been teaching karate to high-school and university students. As a result, karate clubs had sprung up at higher education institutions all over Japan—which is another reason why karate has become as respected as it is today.

In the air raids of World War II, the Shotokan dojo was destroyed, and the growth of karate came to a halt. But after the war, followers of Funakoshi's way re-grouped, and in 1949 they formed the Japan Karate Association, with Funakoshi Gichin as Supreme Master.

On April 10, 1957, the Ministry of Education gave official recognition to the JKA, and it became a legal entity. A mere sixteen days later, at the age of 89, Master Funakoshi passed away. A large public memorial service was held at the Ryogoku Kokugikan (Ryogoku National Sumo Hall), attended by more than 20,000 people, including many famous names who came to pay their respects.

A memorial monument to Master Funakoshi was established at Enkakujji Temple in Kamakura. Members of the JKA pay an honorary visit on April 29th each year, the date of the Shoto Festival.

## Master Nakayama Masatoshi



Master Nakayama Masatoshi had martial arts in his blood. Born in April 1913 in Yamaguchi Prefecture, he was a descendant of the Sanada clan, in the Nagano region. His ancestors were highly-skilled instructors of kenjutsu (the art of swordsmanship).

Upon entering Takushoku University in 1932, Master Nakayama immediately joined the university's karate club, studying under Master Funakoshi Gichin and one of the master's sons, Funakoshi Yoshitaka. Deciding to devote his life to karate, he traveled to China after graduation for further study and training.

When he returned from China in May 1946, he got together with fellow Shotokan practitioners from his university days to revive the Shotokan karate tradition with Funakoshi Gichin as Supreme Master. Together, in 1949, they established the Japan Karate Association. In 1955 a headquarters dojo was built at Yotsuya in Tokyo. It spurred the building of JKA branch dojo all across Japan.

The efforts of the Japan Karate Association to embody and promote the spirit of karate-do were highly regarded by the Ministry of Education (now Ministry of Education, Science, Sports, and Culture). In 1957, the Ministry granted the JKA exclusive legal recognition in Japan as an official association of members for the promotion of the way of karate.

During that time and over the next several years, Master Nakayama made immeasurable contributions to the art. He developed, together with his fellow JKA instructors, a new, rational method of teaching that was tailored to the level and goals of each student: karate as a physical development tool, karate as a method of self-defense, karate for matches, etc. He also emphasized the necessity for each aspect of training to be physically and kinesthetically practical, and he scientifically analyzed how to make them so.

Moreover, to ensure that the true essence of karate-do was being passed on correctly, he and his disciples established a two-year specialist instructor training program, which is still the only specialist instruction system in the world of karate. And the training never ends; the JKA is, and always has been, the only karate organization whose full-time instructors continue to get together every day for joint practice. Through this program, JKA instructors constantly endeavor to refine and perfect their karate.

Master Nakayama also invented karate's first match system: the first ever JKA All Japan Karate Championship was held at Tokyo Metropolitan Gymnasium in October, 1957—and was attended by so many participants and spectators that the venue was filled to capacity.

His adaptation of kata and kumite for the match system was a huge success; the 5th JKA All Japan Karate Championship in 1961 was even attended by His Majesty the Crown Prince of Japan (now His Majesty the Emperor of Japan). Karate was growing increasingly popular throughout the world.

Master Nakayama valued the spiritual aspects of karate that his teacher Funakoshi Gichin espoused—especially the virtue of modesty and the spirit of harmony. He never tired of teaching, by his example more than his words, that to demonstrate these qualities requires not only a deep sense of propriety, but also a constant remembrance that “there is no first attack in karate.”

In actual practice, Master Nakayama insisted that each technique should demonstrate one's powerful and wholehearted personal best. He also emphasized that it is crucial to study the inseparable trinity of karate—*kihon*, *kata*, and *kumite*—as one. And he continually reminded everyone to keep in mind that “the way of karate we pursue is a bare-handed martial art which we practice with an unwavering heart in a state of emptiness; it is a way of developing the personality.”

In his later years, he summarized all his techniques and philosophy in the famous 11-volume series entitled “Best Karate.” Master Nakayama passed away in 1987, at the age of 74.

## Master Sugiura Motokuni



Master Sugiura Motokuni was born on Oct 4, 1924 in Aichi Prefecture. His karate career began in his youth, when he became a student of Shotokan karate. At university he studied under Supreme Master Funakoshi Gichin, and especially with Funakoshi's second son Yoshitaka. He attained his 1st Dan at age 20.

After graduation in 1944, Master Sugiura spent a year in the Tsuchiura Navy Flying Corps, but he soon returned to the martial art he loved, resuming his karate training under Master Nakayama Masatoshi while holding a job at a junior college in Tokyo. During these years, he attained the rank of 3rd Dan.

In 1955, Master Sugiura gave up his job at the junior college and began working full-time in the JKA's Guidance Division. He was also appointed director of the JKA, and assigned to managing the instructors at the headquarters dojo. It was the start of a lifetime of contribution to the art of karate. Not only did he teach at the JKA headquarters dojo, but he also helped establish the rules for tournaments, refereed at matches, and coached at as many as five universities around Tokyo.

In 1958, a year after the Japanese government granted the JKA official recognition, Master Sugiura received his university license as a Physical Education instructor. Over the next five years, he was a part-time Physical Education teacher and lecturer at Asia University, while also attaining his 6th Dan.

In the next decade he began producing materials to help promote the way of karate around the world. In 1961, he helped to edit the textbook "Basics of Karate-do," which identified some common basic errors in karate techniques. In 1963, he created a six-volume, English-language 8mm film entitled "Karate Seminar." In the summer of the same year, he resigned as Director of the JKA, and became a full-time Physical Education teacher.

Master Sugiura's circle of activities kept on expanding. He served as president of the Koganei City Karatedo Federation and Physical Education Association. He joined the Japan Martial Arts Society. And he began creating, in partnership with Kodansha International Ltd., a five-volume video series in Japanese and English on the kata.

Soon Master Sugiura's efforts were attracting attention outside Japan. He was invited to China and Taiwan for the Japan Friendship Karatedo Cup. Then, in August 1975, he went to Los Angeles and Hawaii to attend the International Amateur Karate Federation general meeting and see the JKA-sponsored 7th IAKF Championship. Shortly thereafter, "Monthly Karate-do" magazine began publishing his column.

1976 was another big year for international karate. In August 1976, Master Sugiura—now an 8th Dan, a Karate Technical Committee member, and a full-time professor at Asia University—accompanied the university Alumni Association on an historic visit to Indonesia. Then he was sent to the U.S. to observe how karate was being taught at several American universities.

The next year, Master Sugiura completed his thesis "A System of Karate-do," which discussed the true essence of karate. He spent the next few years creating "Teaching Materials for Karate-do as Physical Education." And in 1989, he drafted the supplementary karate guidelines for these materials.

In March 1990, Master Sugiura retired from his post at Asia University, and the next year was appointed as Chief Instructor of the JKA. In 1992, he received his 9th Dan.

One of Master Sugiura's greatest gifts to the JKA has been his consistent focus on the basics: kihon, kumite and kata. As he emphasizes, kihon teaches us how to move, ensuring our technique is flawless; kumite teaches us how to concentrate, and how to best apply our technique for maximum power; kata teaches us both at once—and opens the way to the body-mind unity that is the soul of karate.

# GOOD LUCK TO ALL PARTICIPANTS

## JKA Official Watch

NEW MODEL LAUNCHED AUGUST 2017 WORLD CHAMPIONSHIPS SEPECIAL EDITION  
WE PRODUCED JKA OFFICIAL WATCHES



Horo Horo Trading Inc.



The tiger logo on the back



Comes with original case with JKA logo



"JKA" inscription on the band



Comes with original box

- JAPANESE AUTOMATIC MOVEMENT
- WATER RESISTANT
- 2017 WORLD CHAMPIONSHIPS LIMITED EDITION
- STAINLESS STEEL

FOR INQUIRIES CONTACT:

DO INC. Hirotaka Ichikawa

Phone : +81 (0) 3-5465-0962 FAX : +81 (0) 3-5465-0964 E-mail : do-hiro@live.jp  
Bldg. 101 19-5 Oyama-cho, Shibuya-ku, Tokyo JAPAN 151-0065

※ Horo Horo Trading Inc. is a sponsor for JKA Karate-Shiroma NY



**F**ire **R**escue **T**raining **S**pecialists

**Noel Casey Safety LTD.**

## Training Courses

### Nation Wide

## Individuals & Groups

- **Confined Space Entry**
- **Chemical Handling**
- **Fire Awareness**
- **Extinguisher Training**
- **Fire Warden**
- **Evacuation Programme**
- **First Aid**
- **Line Rescue**
- **Confined Space with Breathing Apparatus Certified**
- **Emergency Response teams (ERT)**
- **Off Site ERT Training**
- **Search & Rescue**
- **Safe Pass**
- **Health & Safety**
- **Abrasive Wheels**
- **Harness Training**
- **Crisis Management**
- **Command & Control**
- **Manual Handling**
- **Risk Assessment**



Mobile: (087) 413 3653

Office: (021) 434 1056

Web: [www.frts.ie](http://www.frts.ie)

Email: [info@frts.ie](mailto:info@frts.ie)

## Awardee of Distinguished Devotion Japan

**Jorgen Bura**

Denmark

**Sergio Gneo**

Belgium

**Jose Pacheco**

Portugal

**Ted Hedlund**

Sweden

**Daniel Lautier**

France

**Koichi Sugimura**

Switzerland

**Yoshizo Machida**

Brazil

**Mitsuo Inoue**

Argentina

**Johan Roets**

South Africa



## HQ Instructors

### Ueki Masaaki



1. 9th Dan
2. Asia University
3. Tokyo
4. Chief Instructor

### Oishi Takeshi



1. 8th Dan
2. Komazawa University
3. Nagasaki Prefecture
4. Vice Chief Instructor

### Imura Takenori



1. 8th Dan
2. Japan Agriculture Veterinarian
3. Shizuoka Prefecture

### Kurasako Kenro



1. 8th Dan
2. Hosei University
3. Kagoshima prefecture

### Kawawada Minoru



1. 8th Dan
2. Takushoku University
3. Ibaraki Prefecture

### Ogura Yasunori



1. 7th Dan
2. Taisho University
3. Hokkaido prefecture
4. Managing Director

### Imamura Tomio



1. 7th Dan
2. Takushoku University
3. Kagoshima prefecture

### Shiina Katsutoshi



1. 7th Dan
2. Takushoku University
3. Tokyo

### Izumiya Seizo



1. 7th Dan
2. Komazawa University
3. Hokkaido

### Hanzaki Yasuo



1. 7th Dan
2. Taisho University
3. Aomori Prefecture

### Naka Tatsuya



1. 7th Dan
2. Takushoku University
3. Tokyo

### Taniyama Takuya



1. 7th Dan
2. Takushoku University
3. Osaka prefecture

1. Rank 2. Alma Mater 3. Birthplace 4. Position

## HQ Instructors

### Takahashi Satoshi



1.7th Dan  
2.Takushoku University  
3.Osaka prefecture

### Kobayashi Kunio



1.7th Dan  
2.Komazawa University  
3.Tokyo

### Hirayama Yuko



1.6th Dan  
2.Tokyo Women's Physical  
Education College  
3.Kanagawa Prefecture

### Okuma Koichiro



1.6th Dan  
2.Dokkyo University  
3.Kyoto Prefecture

### Nemoto Keisuke



1.5th Dan  
2.Chiba Institute of  
Technology  
3.Chiba prefecture

### Okuei Satomi



1.5th Dan  
2.Komazawa University  
3.Aomori Prefecture

### Kurihara Kazuaki



1.5th Dan  
2.Komazawa University  
3.Ibaraki Prefecture

### Shimizu Ryosuke



1.5th Dan  
2.Kyoto Sangyo University  
3.Kyoto Prefecture

### Chubachi Koji



1.3rd Dan  
2.Teikyo University  
3.Yamagata Prefecture

### Ueda Daisuke



1.3rd Dan  
2.Aoyama Gakuin  
University  
3.Fukuoka Prefecture

### Shiina Mai



1.3rd Dan  
2.Takushoku University  
3.Chiba Prefecture

### Ogane Yutaro



1.3rd Dan  
2.Asia University  
3.Tokyo



Good Luck

Good luck to all the competitors from  
KB Leisurewear

 KB Leisurewear

[kbleisurewear@hotmail.com](mailto:kbleisurewear@hotmail.com)

# ishka

spring water

A warm welcome awaits...

  
CASTLETROY PARK  
HOTEL & LEISURE CLUB  
★★★★

  
SÓ  
HOTELS

Located adjacent to the gates of the University of Limerick  
Offering complimentary Wi-Fi and Parking  
Fine Dining in McLaughlin's Restaurant or the Brasserie

Make your reservation on 061 33 55 66 or email [sales@castletroypark.ie](mailto:sales@castletroypark.ie)



CASTLETROY PARK HOTEL, DUBLIN ROAD, LIMERICK | 061 335566 | [SALES@CASTLETROYPARK.IE](mailto:SALES@CASTLETROYPARK.IE) | [WWW.CASTLETROYPARK.IE](http://WWW.CASTLETROYPARK.IE)



# AROJ - KING OF ASIAN STREET FOOD



ANY MAIN COURSE WITH  
HOMEMADE GELATO ICE CREAM  
LUNCH SPECIAL SERVED  
FROM 12 NOON TO 5PM

€10

11 FROM 5PM TO 10.30.  
EAT IN OR TAKE OUT



061 311411  
WWW.AROI.EU



SALES SERVICE CALIBRATION

**WOMEN'S FITNESS**   
*plus*



"I am thinner now than I was 20 years ago. I have lost 6 stone, 50 inches, 4 dress sizes & 10% body fat. I AM A NEW WOMAN. Not only have I changed physically, but I have also changed mentally. If you had told me that I would feel like this a year ago I would have told you that you were mad. I would highly recommend Women's Fitness Plus and their Kickstart plan. The encouragement you get from everyone is amazing."  
- Maureen, Raheen

**1, 2, 3 to an improved you...**

- 1. Deliver Your Goals On Going Assessment and Bespoke Individual Plans**
  - 2. Manage Your Time Effective Weight Loss & toning in only 30 Minute Sessions**
  - 3. Get Professional Advice Qualified approachable Instructors. We'll Make It Easy.**
- Free Parking. Great Accessibility & State of the Art Changing facilities.**

Get started with  
Limerick's **Biggest** Gym &  
**WEIGHT LOSS** Centre for **women**  
FROM ONLY **€99\*** With our easy  
pay option

**Save €100**  
**KICKSTART PLAN NORMALLY €199 NOW €99**  
**WITH ANY MEMBERSHIP**

### **WEIGHT LOSS CENTRE:**

Qualified Nutritionists, sensible eating plans, ongoing private consultations, continued support & coaching

**Call**  
**061 303586**  
**today**

**Call Today On 061 303586 or visit us at [www.womensgym.ie](http://www.womensgym.ie)**

**Courtfilds Shopping Centre Raheen** *Beside The South Court Hotel*



# **Planet Embroidery**

***Branding Quality Solutions***

**For all your Branding Needs including: Tee Shirts,  
College and School Hoodies, Sports Wear, Corporetae Wear,  
Work Wear, Golf Wear, and Promotional Merchandise**

Unit 10A College Commercial Park, Magazine Road, Cork.

[www.planetembroidery.ie](http://www.planetembroidery.ie)

email: [sales@planetembroidery.ie](mailto:sales@planetembroidery.ie)

Tel: 021-4346788



# NORTHGATE

Vehicle Hire

northgatevehiclehire.ie

ADA



**NORTHGATE**  
Vehicle Hire  
**Proud Sponsors**  
Of



**JKA** WORLD CHAMPIONSHIPS  
17-20 AUGUST 2017



**JKA** 日本空手協会アイランド  
Japan Karate Association Ireland  
The keepers of Karate's highest traditions



<b>Monday 14 August 2017</b>		
15:00 - 17:00	Registration Desk open	UL Sport Arena Reception
<b>Tuesday 15 August 2017</b>		
10:00 - 11:30	Gasshuku - 1st Seminar Ogura Shihan, Imamura Shihan, Naka Shihan	UL Sport Arena
15:00 - 16:30	Gasshuku - 2nd Seminar Ogura Shihan, Imamura Shihan, Naka Shihan	UL Sport Arena
15:00 - 17:00	Registration Desk open	UL Sport Arena Reception
<b>Wednesday 16 August 2017</b>		
10:00 - 11:30	Gasshuku - 3rd Seminar Ueki Shuseki Shihan (Chief Instructor)	UL Sport Arena
14:00 - 15:30	Gasshuku - 4th Seminar Oishi fuku Shuseki Shihan(vice chief Instructor)	UL Sport Arena
15:30 - 17:00	Judge Seminar Free to attend	UL Sport Arena
15:00 - 17:00	Registration Desk open	UL Sport Arena
17:00 - 18:00	World Cup Judge Meeting For Tournament Judges and Director (or Coaches) of all participating Nations	UL Sport Arena
<b>Thursday 17 August 2017</b>		
09:00 - 17:00	Registration Desk open	UL Sport Arena Reception
10:00 - 13:00	Dan Exam	UL Sport Arena
13:00	Qualification Exam Instructor, Examiner, Judge	UL Sport Arena
17:00 - 18:00	International Representative Meeting	Pess Theatre - Pess Building
<b>Friday 18 August 2017</b>		
08:30	Opening of Junior World Championships	UL Sport Arena
09:00	Junior World Championships	
	Closing	
20:00 - 22:00	"Childrens Discom Age 9 - 16"	The Stables Courtyard at UL
<b>Saturday 19 August 2017</b>		
09:00	Senior World Championships	UL Sport Arena
12:00 - 13:00	Lunch break	
13:00	Senior World Championships	
20:00	Band to play at the Stables	The Stables at UL
<b>Sunday 20 August 2017</b>		
08:00	Teams to gather at UL Sport Arena for Opening Ceremony	UL Sport Arena
09:00	Opening cereony	UL Sport Arena
10:30	Finals Senior World Championships	UL Sport Arena
15:00	Award Ceremony	UL Sport Arena
15:30	Final Address	UL Sport Arena
19:00 - 23:30	Sayonara Party	The Stables at UL



# Junior Championship Schedule

Friday 18th August 2017

8:30	Opening Ceremony								
	COURT A	COURT B	COURT C	COURT D	COURT E	COURT F	COURT G	COURT H	
09:00	9	11	12	13	14	15	16-18	19-21	Boy Kata
	10				19				
	19-21	11	16-18	12	10	15	14	13	Girl Kata
	19-21	9	12	14	15	13	11	16-18	Boy Kumite
		10				9			
18:30	15	16-18	11	14	19-21	13	12	10	Girl Kumite
Closing Ceremony									

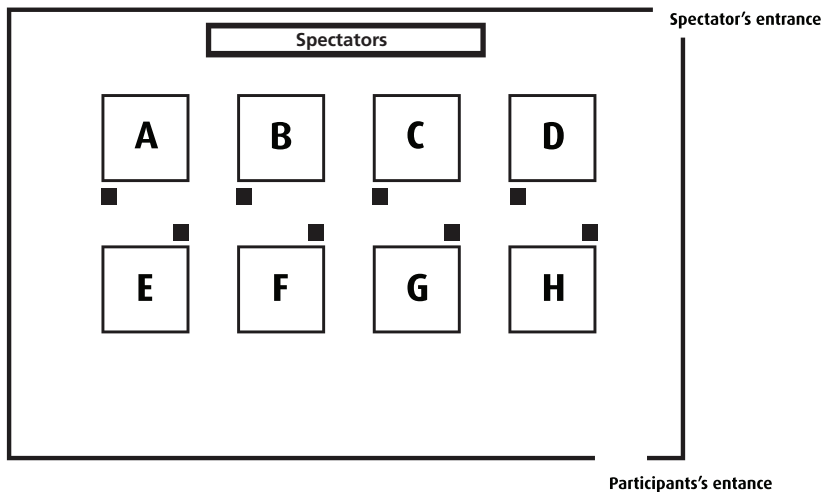

## Senior Championship Schedule

Saturday 19th August 2017

World Karate-do Championship Tournament Schedule								
	COURT A		COURT B		COURT C		COURT D	
09:00	Semi Final				Semi Final			
	Men Team Kata	1~9	Men Team Kata	10~18	Women Team Kata	1~7	Women Team Kata	8~13
	Elimination Match							
~	Women Team Kumite	1~3	Women Team Kumite	4~6	Women Team Kumite	7~9	Women Team Kumite	10~12
	Elimination Match							
	Men Team Kumite	1~5	Men Team Kumite	6~11	Men Team Kumite	12~16	Men Team Kumite	17~21
	Elimination Match							
12:00	Women IND Kata	1~19	Women IND Kata	20~37	Women IND Kata	38~55	Women IND Kata	56~74
	Lunch							
13:00	Elimination Match							
	Men IND Kata	1~29	Men IND Kata	30~59	Men IND Kata	60~88	Men IND Kata	89~117
	Semi Final				Semi Final			
	Women IND Kata	1~37	Women IND Kata	38~55	Men IND Kata	1~59	Men IND Kata	60~88
~	Elimination Match							
	Women IND Kumite	1~15	Women IND Kumite	16~30	Women IND Kumite	31~45	Women IND Kumite	46~60
	Elimination Match							
17:00	Men IND Kumite	1~31	Men IND Kumite	32~62	Men IND Kumite	63~93	Men IND Kumite	94~124

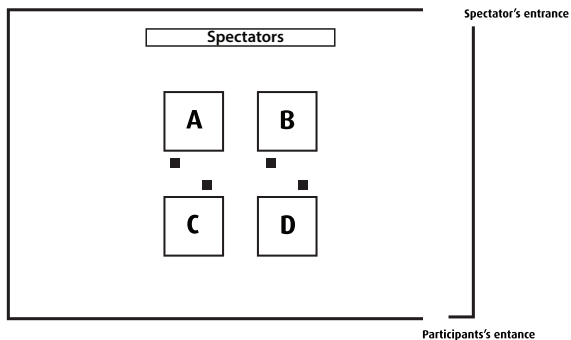

## Senior Championship Finals Schedule

Sunday 20th August 2017

9.00	<b>Opening Ceremony</b>
10.30	Women Team Kata Final
	Women Team Kumite Semi Final
	Men Team Kata Final
	Men Team Kumite Semi Final
	Third Place Match for Women Team Kumite
	Third Place Match for Men Team Kumite
	Women Ind. Kata Final
	Women Ind. Kumite Quarter Final
	Men Ind. Kata Final
	Men Ind. Kumite Quarter Final
	Women Ind. Kumite Semi-Final
	Men Ind. Kumite Semi-Final
	Women Ind. Kumite Final
	Men Ind. Kumite Final
	Women Team Kumite Final
	Men Team Kumite Final
15.00	<b>Award Ceremony</b>
15.30	<b>Final Address</b>

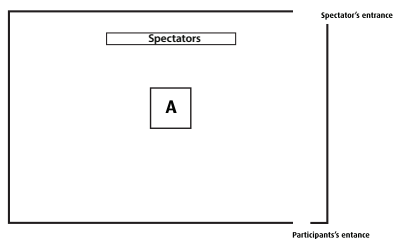

# **RISING SUN**

## **SCHOOL OF KARATE**

JAPAN KARATE ASSOCIATION IRELAND

**36 YEARS OF JKA KARATE-DO 1981-2017**

**St. Anthony's Sports Hall, Ballinlough,  
Cork City, Ireland**

**Barry O Regan. 6th Dan Black Belt J.K.A**

Tel: 086 7222779

[barry@risingsun.ie](mailto:barry@risingsun.ie)

[www.risingsun.ie](http://www.risingsun.ie)





# Bushido

## SHOTOKAN KARATE

---

Strength    Fitness    Flexibility    Competition    Self Defense

---

**Grove Activity Centre**  
15 Ballinderry Park,  
Lisburn BT28 1ST

**Mon 7:30 - 9:00pm**

**Lagan Valley Leisureplex**  
18 Lisburn Leisure Park,  
Lisburn BT28 1LP

**Thurs 7:30 - 9:00pm**  
**Sat 12:00 - 1:30pm**

**Fortwilliam & Macrory Pres. Church**    **Fri 7:15 - 8:45pm**  
577 Antrim Road,  
Belfast BT15 3LJ



Bushido Shotokan Lisburn



stephenf65@icloud.com



07710 086669



@bushidolisburn



www.bushidoshotokan.com



## Age 9 Boys

1	Harry Bates	AUS	8	Kaito Tsukamoto	JPN	15	Daniil Revilo	RUS
2	Clay Sferratore	AUS	9	Taisuke Kobayashi	JPN	16	Dmitry Demidov	RUS
3	Ryan Widjaya	AUS	10	Tanpos Yujin Borja	JPN	17	Egor Eliseev	RUS
4	Mario Rodríguez	COL	11	Toa Kurokawa	JPN	18	Evgeny Ganin	RUS
5	Bence Sarkadi	HUN	12	Yuuma Akimoto	JPN	19	Kirill Anchikov	RUS
6	Fuga Igawa	JPN	13	Zachary Stewart	KWT	20	Kirill Niurenberg	RUS
7	Junpei Ishimabushi	JPN	14	Avnish Sandeep Beekee	MUS	21	Andre Nopal	USA

## Age 10 Boys

1	Joshua Rawlinson	AUS	12	Alam Deen Nabwani	ISR	23	Bogdan Gaidai	RUS
2	Christopher Stingas	AUS	13	Carmel Mansor	ISR	24	Evgenii Beziaev	RUS
3	Matthew Chin	CAN	14	Rayan Hasan	ISR	25	Ilya Tarasov	RUS
4	Hanlin Li	CHN	15	Airu Shimano	JPN	26	Muhammad Yusubov	RUS
5	Miroslav Hovorka	CZE	16	Hisayoshi Tanioka	JPN	27	Tamirlan Khanov	RUS
6	Richard Vasek	CZE	17	Kanta Yamamoto	JPN	28	Timur Nikolaev	RUS
7	Bror Rasmussen	DNK	18	Kento Yoshimura	JPN	29	Yurii Dymov	RUS
8	Chakyl Pattar	FRA	19	Kouhei Fujimura	JPN	30	Alexandros Gauthier	ZAF
9	Jake Stewart	GBR	20	Taiga Nishikawa	JPN	31	Liam Duvenhage	ZAF
10	Botond Hamari	HUN	21	Yamato Shoji	JPN	32	Liam van Schalkwyk	ZAF
11	Gergo Szatmári	HUN	22	Manhisoa Andrianarimanana	MDG	33	Luke Roskam	ZAF

## Age 11 Boys

1	Tomas Bonometti	ARG	17	William Cunningham	ENG	33	Mohamad Alhajry	KWT
2	Tadeo Regner Cunha	ARG	18	Elijah Tavares	FRA	34	Mohamed Markin Waheed	LKA
3	Richard Baskara	AUS	19	Petrus Mollet	FRA	35	Pedro Matos	PRT
4	Rory Gersbach	AUS	20	Gábor Kállai	HUN	36	Ivan Efremov	RUS
5	Evan Malamas	AUS	21	Hasan Made	ISR	37	Konstantin Sedov	RUS
6	Caio Junqueira	BRA	22	Moran Nabwani	ISR	38	Nikita Kaikov	RUS
7	Frederick Vinette	CAN	23	Rayan Qwaiqis	ISR	39	Vadim Sovkov	RUS
8	David Ihaza	CAN	24	Yanir Halabi	ISR	40	Yaroslav Fedorov	RUS
9	Matthew Djanashvili	CAN	25	Haruto Shibuya	JPN	41	Mohamad Ali	UAE
10	Martin Ivchenko	CAN	26	Hinata Shimatsu	JPN	42	Mohamad Ibrahim	UAE
11	Dan Babkin	CAN	27	Kota Yashiro	JPN	43	Msallam Alqubaisi	UAE
12	Santiago Vargas	COL	28	Ren Hinata	JPN	44	Janco Moolman	ZAF
13	Mark Christian Seemann	CZE	29	Taiga Ishikawa	JPN	45	Kadin Norval	ZAF
14	Martin Javansky	CZE	30	Towa Usami	JPN	46	Mathew Wentzel	ZAF
15	Tomas Novotny	CZE	31	Yuga Takeyama	JPN	47	Tendai Ankunde	ZAF
16	Viktor Lam	ENG	32	Yuki Kon	JPN	48	WJ Fourie	ZAF

## Age 12 Boys

1	Franco Gianluca	ARG	17	Bálint Muhari	HUN	33	Muqsit Ali	PAK
2	Jake Sferratore	AUS	18	Lorincz Bednarik	HUN	34	Aleksandr Maksimov	RUS
3	Curtis Sproxtton	AUS	19	Máté Miskovitz	HUN	35	Dmitrii Butaev	RUS
4	Nathan Wilkinson	AUS	20	Roland Karakó	HUN	36	Dmitriy Shlepov	RUS
5	Jack McCaughtrie	AUS	21	Janardan Deka	IND	37	Gennadiy Malchushkin	RUS
6	João Felipe Rosa	BRA	22	Jamil Abo-Sada	ISR	38	Georgy Pankov	RUS
7	Christopher Chin	CAN	23	Khalid Zubidat	ISR	39	Ramil Gumiarov	RUS
8	Darian Nasirzadeh	CAN	24	Gouse Konishi	JPN	40	Timur Atazhanov	RUS
9	Tyson Cragg	CAN	25	Hayato Satake	JPN	41	Mahmoud Maher	UAE
10	Jacob Pichhadze	CAN	26	Koga Tamuro	JPN	42	Arjun Thulsie	ZAF
11	Raul Quijada	CHL	27	Rinya Li	JPN	43	Connor Harris	ZAF
12	Cristopher Fernandez	CHL	28	Ryo Mizuta	JPN	44	Galaletsang Rathebe	ZAF
13	Daniel Havlicek	CZE	29	Ryuunosuke Saito	JPN	45	Jessam Khadraoui	ZAF
14	András Káldi	HUN	30	Takakiyo Iguchi	JPN	46	Julio Bartolo	ZAF
15	Attila Bihari	HUN	31	Tarou Kouno	JPN	47	PW Pentz	ZAF
16	Attila Káldi	HUN	32	Cedrick Mougín	MDG	48	Tyj Purchase	ZAF

## Age 13 Boys

1	Lachlan Isles	AUS	21	Mark Chapier	FRA	41	Teiva Samfat	MUS
2	Flynn Bushell	AUS	22	Samy Sadoudi	FRA	42	Aleksandr Toropov	RUS
3	Deen Selmanovic	AUS	23	Blair Flynn	GBR	43	Amir Sharapov	RUS
4	Bashtion Littlefair	AUS	24	Dylan Buckley	GBR	44	Ivan Latkin	RUS
5	Kaden Renwick	AUS	25	Kyle Bruce	GBR	45	Leonard Khomiakov	RUS
6	Joseph Stoneman	AUS	26	Lewis Simpson	GBR	46	Semen Kutiashev	RUS
7	Daniel Morais Kunz	BRA	27	Gábor Barki	HUN	47	Sergei Mutovkin	RUS
8	João Pedro Hioki	BRA	28	Gábor Máté	HUN	48	Vladislav Kostiuikov	RUS
9	Luis André Alencastro	BRA	29	Máté Jele	HUN	49	Eisuke Murakoshi	SGP
10	Pedro Feuerharnael	BRA	30	Atiya Omariyyah	ISR	50	ABDEL RAHMAN Fatehi	UAE
11	Louis Adrar	CAN	31	Eial Shomre	ISR	51	Ali Mohamad	UAE
12	Shayan Hoghooghi	CAN	32	Rodi Lelawi	ISR	52	Saad Ali	UAE
13	Adam Nunvar	CAN	33	Yousef Daher	ISR	53	Youssef Ibrahim	UAE
14	Aiden Walsh	CAN	34	Kaito Ishii	JPN	54	David Matutis	USA
15	José D. Suarez	CHL	35	Kosuke Nagatsuka	JPN	55	Callum Haskell	ZAF
16	Juan Felipe Vargas	COL	36	Kouki Yamazaki	JPN	56	Carl Van Niekerk	ZAF
17	Pavel Pospisil	CZE	37	Sena Naito	JPN	57	Deigo Watson	ZAF
18	Maxim Simon	CZE	38	Syoma Hatanaka	JPN	58	Estiaan Cronje	ZAF
19	Tobias Lindbock	DNK	39	Abdulaziz Nayfeh	KWT	59	Ruan Cronje	ZAF
20	Julien Derosiaux	FRA	40	Mitoyo Andrianaho	MDG	60	Xavier Strydom	ZAF

## Age 14 Boys

1	Joaquin Calbelo	ARG	21	Bertram Kvist	DNK	41	Yusei Suetake	JPN
2	Antonio Castañeira	ARG	22	Tosan Awani	ENG	42	Tokiniaina Razafindrabe	MDG
3	Bodhi Gallagher	AUS	23	Kenji Escriva	FRA	43	Valentini Randriambololona	MDG
4	Ryan Daly	AUS	24	Khamzat Muanev	FRA	44	Jose Medina	MEX
5	Cole Waite	AUS	25	Callum Flynn	GBR	45	Stefan Kluivers	NLD
6	Rodolfo Figueiredo	BRA	26	Attila Baumann	HUN	46	Mikel Diaz	PAN
7	Diogo Domingues	BRA	27	Dominik Stum	HUN	47	Danila Mashchenko	RUS
8	Miguel Cumeira	BRA	28	Kristóf Czibolya	HUN	48	Ilia Pavlov	RUS
9	Luigi Ferraro	BRA	29	Liam Mc Carthy	IRL	49	Iurii Gutenko	RUS
10	Andy Phok	CAN	30	Lucas Thornton	IRL	50	Nikita Eliseev	RUS
11	Khayden Cesar-Mohammed	CAN	31	Amit Davidov	ISR	51	Nikita Medonii	RUS
12	Harley Eiley	CAN	32	Kamal Fares	ISR	52	Nikolai Astakhov	RUS
13	Ali Afrasiabi	CAN	33	Omer Friedlander	ISR	53	Timofei Fazly	RUS
14	Nicolás Gómez	CHL	34	Tal Vaisman	ISR	54	Benjamin Farris	USA
15	Ondrej Bosak	CZE	35	Gin Takahashi	JPN	55	Anthony van der Watt	ZAF
16	Filip Konecny	CZE	36	Kenshiro Sato	JPN	56	Cameron Varga	ZAF
17	Martin Prech	CZE	37	Ryo Iwabuchi	JPN	57	Darian Booyesen	ZAF
18	Tobias Suchanek	CZE	38	Ryohei Yuge	JPN	58	Kieran Stadler	ZAF
19	Bruno Vogel	DEU	39	Taisei Koga	JPN	59	Shrimay Manilal	ZAF
20	Tomm Janik	DEU	40	Yamato Satou	JPN	60	Tristan Clark	ZAF

## Age 15 Boys

1	Franco Jacquet	ARG	19	Erwyn Pattar	FRA	37	Aleksandr Danilov	RUS
2	Pehuen Naranjo	ARG	20	Ádám Veress	HUN	38	Denis Bobrov	RUS
3	Brae Wagner	AUS	21	Csongor Berta	HUN	39	Maksim Gabov	RUS
4	Lucas Decker	AUS	22	Richárd Ugró	HUN	40	Ostap Pushkov	RUS
5	Kane Briggs	AUS	23	Muhammad Adriel Hafiz Isaeni	IDN	41	Petr Pershin	RUS
6	Rondon Caiado	BRA	24	Kaishin Watanabe	JPN	42	Vadim Kuklin	RUS
7	Raul Rocha	BRA	25	Kanta Ootsu	JPN	43	Victor Fomiryakov	RUS
8	Ariel Crisostomo	CAN	26	Kohei Sedaka	JPN	44	Vladimir Semchishin	RUS
9	Andru Teece	CAN	27	Naruya Hashimoto	JPN	45	Kron Osmani	SUI
10	Angelo Reoligio	CAN	28	Rekka Aizawa	JPN	46	August Tierney	USA
11	Jaime Gómez	CHL	29	Soichiro Yoshida	JPN	47	Kim Torres	USA
12	Diego Casas	CHL	30	Sora Soma	JPN	48	Timothy Rinaldi	USA
13	Jun'an Li	CHN	31	Toki Inada	JPN	49	Tino Damiani	USA
14	Adam Kriz	CZE	32	Mohamed Shuaib Rahuman	LKA	50	Daniel Class	ZAF
15	Simon Lev	CZE	33	Dylan Rabary	MDG	51	Hendrik Smits	ZAF
16	Adrian Bosse	DEU	34	Kiady Ramparison	MDG	52	Jayden Weaver	ZAF
17	Arthur Keller	DEU	35	Mami Mick Raveloson	MDG	53	Rorisang Mookane	ZAF
18	Minh Doan	DEU	36	Toavina Rakotovao	MDG	54	Therin-John de Meyer	ZAF



## Age 16-18 Boys

1	Facundo Burgos	ARG	30	Pavel Zach	CZE	59	Takumi Hasegawa	JPN
2	Facundo Tejerina	ARG	31	Oliver Simon	CZE	60	Osama AlMohamad	KWT
3	Gerard Felipe	AUS	32	Marton Lozsi	CZE	61	Ando Rakotoniaina	MDG
4	Aaron Wairon	AUS	33	Luca Di Fazio	DEU	62	Brandon Rakotomalala	MDG
5	Omar Selmanovic	AUS	34	Paul Bosse	DEU	63	Mario Andrianimanana	MDG
6	Lachlan Fenton	AUS	35	Roman Dinh	DEU	64	Camilo de la Vega	MEX
7	Coenraad Van Wyke	AUS	36	Tim Burkhardt	DEU	65	Juan Medina	MEX
8	Ricardo Hadfield	AUS	37	Tom Priebernig	DEU	66	Aumeeruddeen Allybocus	MUS
9	Nikita Buchinskiy	BEL	38	Marcus Lindbock	DNK	67	Dhirendra Sembhoo	MUS
10	Yohan Raveydt	BEL	39	Noor Kanamat	DNK	68	Ole Even Refnes	NOR
11	Enzo Pantoja	BRA	40	Syed Tauhid Bukhari	DNK	69	Ken Hanyu	NZL
12	Thomaz Frassá	BRA	41	Alfie Cunningham	ENG	70	Hashim Ambusaidi	OMN
13	Lucas Venito	BRA	42	Cian Moroney	ENG	71	Diego Castillo	PAN
14	Danilo Cals	BRA	43	Endri Krasniqi	ENG	72	Filipe Moniz	PRT
15	Bernardo Barreto	BRA	44	Kenzo Lambert	FRA	73	Leandro Dias	PRT
16	Piasky Simões	BRA	45	Romain Gatoux	FRA	74	Daniil Subbotin	RUS
17	Granados Leopoldo	CAN	46	Blair Wighton	GBR	75	Dmitry Didenko	RUS
18	Joshua Basilan	CAN	47	Calvin Bruce	GBR	76	Karim Salimgareev	RUS
19	Shelby Gingras	CAN	48	Daniel Simpson	GBR	77	Kirill Kuznetsov	RUS
20	Adrian Reyes	CAN	49	Bence Szlávik	HUN	78	Nikita Belovoshchev	RUS
21	Peter Ihaza	CAN	50	Martin Pászti	HUN	79	Sergei Gudkov	RUS
22	Mario Biscotti	CAN	51	Máté Kovács	HUN	80	Sviatoslav Pokrovskii	RUS
23	Yerko Mella	CHL	52	Axel Hendy Putra	IDN	81	Marc Reinbold	SUI
24	Hector Tapia	CHL	53	Zohar Ben Yishay	ISR	82	Michael Umayam	USA
25	Franco Briones	CHL	54	Ishin Kitazawa	JPN	83	Chadwin Deyssel	ZAF
26	Tomas Hana	CZE	55	Masaya Tokuda	JPN	84	Luke Mills	ZAF
27	Martin Hana	CZE	56	Ryosuke Jinnai	JPN	85	Shaugne van der Watt	ZAF
28	Daniel Matousek	CZE	57	Takahiro Kanamori	JPN	86	Thabiso Ramalitsi	ZAF
29	Daniel Benes	CZE	58	Takeru Kurita	JPN	87	Zander Human	ZAF

## Age 19-21 Boys

1	Luis Millahuala	ARG	24	Jakub Studeny	CZE	47	Jan Martin Huus	NOR
2	Jose Romero	ARG	25	Ayman Romdhane	DEU	48	Binod Roka	NPL
3	Francisco Ainaridi	ARG	26	Ayman Romdhane	DEU	49	Sushant Modak	NPL
4	Liam Murphy	AUS	27	David Matz	DEU	50	Rafael Serrano	PAN
5	Edward Hopkins	AUS	28	David Matz	DEU	51	Aidar Khametov	RUS
6	Christopher Cook	AUS	29	Luca Weingoetz	DEU	52	Pavel Lvov	RUS
7	David Giles	AUS	30	Steven Kaun	DEU	53	Sergey Mashchenko	RUS
8	Joseph Flood	AUS	31	Steven Kaun	DEU	54	Timur Sayadov	RUS
9	George Kouloumentas	AUS	32	Aaron Storey	ENG	55	Vladimir Shishkin	RUS
10	Lucas Coimbra	BRA	33	Antonio Ml. Castro	ESP	56	Vsevolod Popov	RUS
11	Petterson Lozinsky	BRA	34	Finlay Easson-Brausch	GBR	57	Emil Sehovac	SWE
12	Leão Mazur	BRA	35	Gregor Duclair	HTI	58	Kristoffer Raskov	SWE
13	João Lima	BRA	36	Bendjy Dieujuste	HTI	59	Abdullah Jarushi	USA
14	Marcelo Silva	BRA	37	Bence Kovács	HUN	60	Damien Boltd	USA
15	Rafael Gameiro	BRA	38	Levente Berényi	HUN	61	Harrison Rahn	USA
16	Jean-Gabriel St.Julien	CAN	39	Kohei Nagao	JPN	62	Kym Torres	USA
17	Richie Phok	CAN	40	Takumi Nakata	JPN	63	Almaro De Villiers	ZAF
18	Camillo Longo	CAN	41	Tatsuki Makino	JPN	64	Chris Valarakis	ZAF
19	Camilo Veloza	CHL	42	Yuuki Toyota	JPN	65	Jean-Pierre Michau	ZAF
20	Fabian Huaiquimán	CHL	43	Yuya Hashimoto	JPN	66	Jordan Ross	ZAF
21	Milan Soltys	CZE	44	Fabien Randriamparany	MDG	67	Wynand Viviers	ZAF
22	Filip Vit	CZE	45	Lalaina Rajaonarison	MDG			
23	Ondrej Zampach	CZE	46	Daniel Martinez	MEX			

## Men

1	Marcelo Monzon	ARG	40	Brian Nguyen	CAN	79	Axel Joao	FRA
2	Ramon Aguirre	ARG	41	Paul Atkin	CAN	80	Cedric Pissis	FRA
3	Jorge Rivas	ARG	42	Seiji Saeki	CAN	81	Etienne Allot	FRA
4	Roberto Mendes	ARG	43	Rodrigo Rojas	CHL	82	Francois Reydellet	FRA
5	Federico Hussein	ARG	44	Mauro Fuentes	CHL	83	Paul De Villepin	FRA
6	Diego Montez	ARG	45	Camilo Sandoval	CHL	84	Yohan Boudot	FRA
7	Artyom Vanesyan	ARM	46	Julio Silva	CHL	85	Colin Flynn	GBR
8	Sevak Hakobyan	ARM	47	Oscar Arancibia	CHL	86	James Campbell	GBR
9	Vahagn Vardanyan	ARM	48	Alvaro Bravin	CHL	87	Nick MacKay	GBR
10	Tigran Harutyunyan	ARM	49	Yanlei Shen	CHN	88	Pierre Vendredi	HTI
11	Sahak Azatyan	ARM	50	Armando Vargas	COL	89	Kens Cazeau	HTI
12	Cameron Sparkes	AUS	51	Andreas Louca	CYP	90	Evens Joiseus Nader	HTI
13	Adis Kadic	AUS	52	Jan Drobecek	CZE	91	Fedlyn Joseph	HTI
14	Mark Smith	AUS	53	Jakub Kolek	CZE	92	Dieuseul ST Nozier	HTI
15	Nicholas Tognela	AUS	54	Adam Zdobinsky	CZE	93	Balázs Gyimesi	HUN
16	Edhem Kadic	AUS	55	Marek Babor	CZE	94	Balázs Vágvyölygi	HUN
17	Matthew Ellem	AUS	56	Jan Stekly	CZE	95	Dániel Boros	HUN
18	Nurija Kadic	AUS	57	Josef Pacovsky	CZE	96	Gergo Ocsovai	HUN
19	Arnaud Vicaire	BEL	58	Daniel Wessendorf	DEU	97	Szabolcs Németh	HUN
20	Kristof Vermeulen	BEL	59	Dennis Braun	DEU	98	Zsolt Habda	HUN
21	Jonathan Mulolo	BEL	60	Dustin Deissler	DEU	99	Barry Tapster	IRL
22	Abdelkarim Bouzkik	BEL	61	Florian Herrmann	DEU	100	Keelan Gannon	IRL
23	Gianni Schotte	BEL	62	Frieder Diegner	DEU	101	Martin Cadwell	IRL
24	Thusara Gallage	BHR	63	Jakob Schmidt	DEU	102	Stephen Bell	IRL
25	Ankur Sharma	BHR	64	Stefan Effler	DEU	103	Stephen O Connor	IRL
26	Marcelo Kanashiro	BRA	65	Stefan Walsleben	DEU	104	Amir Malak	ISR
27	Marcel Raimo	BRA	66	Jacob T. Nissen	DNK	105	Emad Sawaed	ISR
28	Douglas Albano	BRA	67	Alistair Bevan	ENG	106	Zohar Kablan	ISR
29	Fernando Macedo	BRA	68	Tresor Mashaka	ENG	107	Angelo Curcuraci	ITA
30	Jayme Sandall	BRA	69	George Draganov	ENG	108	Edoardo Barzaghi	ITA
31	Frank Manera	BRA	70	Mensah Oteh	ENG	109	Fabrizio Curcuraci	ITA
32	Rafael Moreira	BRA	71	Mohammed Salih	ENG	110	Lorenzo Ninicato	ITA
33	Fábio Simões	BRA	72	ALFONSO GIL	ESP	111	Stefano De Bartolomeo	ITA
34	China Metswi	BWA	73	DAVIDA DELICADO	ESP	112	Keisuke Nemoto	JPN
35	Colin Chin	CAN	74	JOSE MARIA RAMIREZ	ESP	113	Yasunori Okada	JPN
36	Thomas Chin	CAN	75	MIGUEL ANGEL LASTRA	ESP	114	Yusuke Haga	JPN
37	Trevor Ishmael	CAN	76	MIGUEL CASTRODEZA	ESP	115	Daisuke Ueda	JPN
38	Diyari Azad	CAN	77	SERGIO HERNANI	ESP	116	Kazuaki Kurihara	JPN
39	Hugo DeGroot	CAN	78	Alexandre Boueste	FRA	117	Hidemoto Kurihara	JPN

118	Yushi Hakidume	JPN	146	Tobias Schmidt	NLD	174	Kurt Wyler	SUI
119	Abdullah Barakat	KWT	147	Anh Le Phan Thai	NOR	175	Tobias Müller	SUI
120	Eric Mathon	MCO	148	Benjamin Skaatun	NOR	176	Florjan Reiter	SVN
121	Alexandre Blonda	MCO	149	Hans Andre Skaatun	NOR	177	Goran Milovanovi	SVN
122	Mathieu Magara	MCO	150	Binod Maharjan	NPL	178	Andreas Schliker A.	SWE
123	Arnold Chep	MCO	151	Suqer Alghafri	OMN	179	Daniel Vogel	SWE
124	Jimmy Bernard	MCO	152	Mohamed Alkindi	OMN	180	Jozef Berglez	SWE
125	Florent Carpentier	MCO	153	Aamir Mehboob	PAK	181	Kim Olsson	SWE
126	Karim Agrebi	MCO	154	Nasrullah	PAK	182	Sam Biranvand	SWE
127	Xavier Grammatico	MCO	155	Hussain Ali Changezi	PAK	183	Ken Hua Shang	TWN
128	Billy Ralainambinina	MDG	156	Abdullah	PAK	184	Ahmed Hamdallah	UAE
129	Eric Randrianarivelo	MDG	157	Carlos Santos	PAN	185	Taha Bahnasi	UAE
130	Joseph Rafiarenana	MDG	158	Josue Ramos	PAN	186	Andre Fiallos	USA
131	Josué Ratsimbarison	MDG	159	Marco Pazmino	PAN	187	Dimitri Papadopoulos	USA
132	Maka Andoniaina	MDG	160	Rafael Nunes	PRT	188	Joe Vincente	USA
133	Patrick Rijaharitiana	MDG	161	Ricardo Maldonado	PRT	189	Jovani Marulanda	USA
134	Tantely Radoniaina	MDG	162	BOGDAN DOLINSCHI	ROU	190	Khim Torres	USA
135	Toky Rajaonarison	MDG	163	DORU BURDAN	ROU	191	Ryu Goto	USA
136	Daniel Arceo	MEX	164	Aleksandr Avvakumov	RUS	192	Luis Aranguren	VEN
137	David Borjas	MEX	165	Arsen Baikhadzhiev	RUS	193	David Ho Tong	ZAF
138	Jose Negrete	MEX	166	Inal Khatkov	RUS	194	Lorenzo Helena	ZAF
139	Jose Negrete	MEX	167	Maksim Votikov	RUS	195	Michael Thompson	ZAF
140	Luis Lopez	MEX	168	Marat Sharafeev	RUS	196	Sandile Makwali	ZAF
141	Miguel Garibay	MEX	169	Marsel Gainutdinov	RUS	197	Sibongiseni Ngwenya	ZAF
142	Nicolas Cardona	MEX	170	Vladislav Erokhin	RUS	198	Joseph Kasweka	ZMB
143	Santiago Manrique	MEX	171	Cyril Martins	SGP	199	Kelvin Yamboto	ZMB
144	Dario Chircop	MLT	172	Benjamin Lüthi	SUI	200	Robert Chisanga	ZMB
145	Etienne Ceci Bonello	MLT	173	Kobithan Yoganathan	SUI	201	Seth Sibanda	ZMB

## Age 9 Girls

1	Emily Wyatt	COL	5	Ichika Harashino	JPN	9	Ryoka Takikawa	JPN
2	Csenge Takács	HUN	6	Kokomi Ochikubo	JPN	10	Bibi Sultan	KWT
3	Haruka Ohama	JPN	7	Masumi Simura	JPN	11	Ainel Temralieva	RUS
4	Honoka Mochizuki	JPN	8	Mika Kurihara	JPN	12	Ekaterina Chistova	RUS

## Age 10 Girls

13	Chloe Van Emmenis	AUS	21	Hiyori Koda	JPN	29	Anna Sheina	RUS
14	Sofia Wyatt	COL	22	Kokomi Ichiba	JPN	30	Ekaterina Shilkova	RUS
15	Mia Simonova	CZE	23	Maria Yasuda	JPN	31	Radmilla Namazbaeva	RUS
16	Helena Prechova	CZE	24	Narumi Hariya	JPN	32	Ashley Viljoen	ZAF
17	Marie Dobsova	CZE	25	Sayaka Fujii	JPN	33	Elri van der Westhuizen	ZAF
18	Voktorie Maskova	CZE	26	Yuzuki Soken	JPN	34	Gabrielle Woest	ZAF
19	Akari Orito	JPN	27	Alina Bekbulatova	RUS			
20	Akari Saito	JPN	28	Anastasiia Diakonova	RUS			

## Age 11 Girls

1	Danielle Aragon	AUS	11	Shira Davidov	ISR	21	Iavo Ramparison	MDG
2	Aidyn Dagenais-Adler	CAN	12	Airi Kuzuhara	JPN	22	Maiia Kosareva	RUS
3	Yan Kelly	CAN	13	Junna Okamoto	JPN	23	Polina Nagovitsina	RUS
4	Sara Sharp	CAN	14	Kaho Hirashima	JPN	24	Polina Zubareva	RUS
5	Yujun Yang	CHN	15	Maho Ina	JPN	25	Sofya Riabkova	RUS
6	Eliska Kudrnova	CZE	16	Mayo Taketsuna	JPN	26	Victoria Savina	RUS
7	Eliska Javanska	CZE	17	Renna Matsumoto	JPN	27	Mikaella Torres	USA
8	Julie Farine	FRA	18	Sara Kosugi	JPN	28	Mignon van Zyl	ZAF
9	Rajad Amaria	ISR	19	Syoka Sekii	JPN	29	Soultana Titzivacos	ZAF
10	Shaden Abo Yosif	ISR	20	Lolwa Kotb	KWT	30	Yzla Schenk	ZAF

## Age 12 Girls

1	Louisa Neill	AUS	12	Mille Loland	DNK	23	Ruri Yamagishi	JPN
2	Shinju Littlefair	AUS	13	Eszter Szatmári	HUN	24	Anna Kuznetsova	RUS
3	Beatriz Silva	BRA	14	Szonja Szilaski	HUN	25	Varvara Drokina	RUS
4	Erica Eiley	CAN	15	Fatma Amaria	ISR	26	Aya Mohamad	UAE
5	Alena Demidova	CAN	16	Raha Hilf	ISR	27	Noora Alqubaisi	UAE
6	Valentina Vergara	CHL	17	Akari Funamizu	JPN	28	Ariana Ruiz	USA
7	Lua Tenorio	CHL	18	Arika Horie	JPN	29	Kaitlyn Nagatomo	USA
8	Isidora Gallo	CHL	19	Kanae Takahashi	JPN	30	Karin De Jager	ZAF
9	Sara Konecna	CZE	20	Karin Suzuki	JPN	31	Lelani Viviers	ZAF
10	Katerina Hermanova	CZE	21	Miku Matoba	JPN	32	Meruska Massyn	ZAF
11	Zuzana Sokolova	CZE	22	Miyu Maeda	JPN			

## Age 13 Girls

1	Camila Martinez	ARG	13	Anna Kaiser	HUN	25	Aleksandra Basovskaya	RUS
2	Jacinta Mudie	AUS	14	Airi Sekizawa	JPN	26	Anna Beliaeva	RUS
3	Jamie Bridgeman	AUS	15	Airi Takikawa	JPN	27	Bogdana Vorchik	RUS
4	Emielia Jansen	AUS	16	Aoi Fukuda	JPN	28	Daria Bogdanova	RUS
5	Eliana Eisenberg	CAN	17	Karen Imatomi	JPN	29	Diana Korepanova	RUS
6	Ophelie Darche	CAN	18	Rimi Ina	JPN	30	Yuki Hoshi	USA
7	Monika Brucknerova	CZE	19	Hina Sakai	JPN	31	Alexi Frick	ZAF
8	Sara Ferencova	CZE	20	Mimi Beppu	JPN	32	Lara Van Rensburg	ZAF
9	Adela Matouskova	CZE	21	Omoto Yokosaka	JPN	33	Michaela Herbert	ZAF
10	Isabelle M. Tissot	DNK	22	Brenda Rakotomalala	MDG	34	Monique Van Der Merwe	ZAF
11	Amy McNally	GBR	23	Natalia Lopez	MEX	35	Wilmari Olivier	ZAF
12	Lia McLaren	GBR	24	Natalia Breidenbach	NLD			

## Age 14 Girls

1	Alma Sabalich	ARG	14	Victoria Hauelsen	DEU	27	Dayna Slangen	NLD
2	Guillermina Fitz Maurice	ARG	15	Lea B. Nielsen	DNK	28	Glafira Aleinik	RUS
3	Tara Daly	AUS	16	Mia Lam	ENG	29	Lillia Korotkaia	RUS
4	Makenzie Rowe	AUS	17	Lucy Hull	GBR	30	Margarita Bekbulatova	RUS
5	Georgina Waser	AUS	18	Rebeka Szalai	HUN	31	Viktoriiia Miakota	RUS
6	Zoe Garifallou	AUS	19	Sahar Shkhedem	ISR	32	Nadein Mohamad	UAE
7	Manuela Simão Coelho	BRA	20	Haruna Suzuki	JPN	33	Carmen Rojas	USA
8	Ana Paula Sukiennik	BRA	21	Karin Sato	JPN	34	Teresita Salas	USA
9	Ismaya Moraes	BRA	22	Kokoro Shintani	JPN	35	Beate Van Der Linde	ZAF
10	Emily Jiang	CHN	23	Kotoha Komai	JPN	36	Drew Townley	ZAF
11	Aneta Zitkova	CZE	24	Nanami Hyuga	JPN	37	Jaydene Naidoo	ZAF
12	Nikola Melicharova	CZE	25	Kajitsu Sakata	JPN	38	Yayra Ankude	ZAF
13	Michaela Soukupova	CZE	26	Houtashna Sembhoo	MUS			

## Age 15 Girls

1	Aluen Paz Dovis	ARG	17	Tia Molesbury	ENG	33	Aleksandra Filatova	RUS
2	Rosey Cameron	AUS	18	Iona Barclay	GBR	34	Diana Palchikova	RUS
3	Ciarah Shandiman	AUS	19	Lucy Ferguson	GBR	35	Nika Prusova	RUS
4	Felicity Gersbach	AUS	20	Anna Vajvoda	HUN	36	Seline Bagderelli	SUI
5	Ana Luisa Venito	BRA	21	Janka Groh	HUN	37	Sammi Yeung	USA
6	Sara Hughes	CAN	22	Réka Pintér	HUN	38	Yana Weng	USA
7	Audrey-Ann Rioux	CAN	23	Rekan Khaldy	ISR	39	Evelyn Mtetwa	ZAF
8	Eden Duffy	CAN	24	Kokoro Kanezaki	JPN	40	Gabriella Alessandri	ZAF
9	Cali Dixon	CAN	25	Saki Hirano	JPN	41	Matuschka De Jager	ZAF
10	Kimmy Vega	CHL	26	Saki Nakayama	JPN	42	Micaela Palmer	ZAF
11	Adela Jiraskova	CZE	27	Sawane Nishimoto	JPN	43	Romy Nathan	ZAF
12	Kristyna Tesarova	CZE	28	Yumine Fujisawa	JPN	44	Zoe Junge	ZAF
13	Celina Kreutz	DEU	29	Franciska Sprok	KWT			
14	Luisa Schlien	DEU	30	Maaïke Weijl	NLD			
15	Alberte Olsen	DNK	31	Paloma Wewenggang	NLD			
16	Mille Illum Oldenburg	DNK	32	Charlotte Anfinsen	NOR			

## Age 16-18 Girls

1	Florencia Gimenez	ARG	30	Josefine Søgaard	DNK	59	Danine van den Ham	NLD
2	Candelaria Fernandez	ARG	31	Leonora E.C. Skjoldemose	DNK	60	Kelsey Drent	NLD
3	Peyten Bridgeman	AUS	32	Sif Rasmussen	DNK	61	Anni Skaatun	NOR
4	Joanna Briones	AUS	33	Abigail Good	ENG	62	Ingrid S. Mjaatvedt	NOR
5	Kendra Mingo	AUS	34	Shekinah Bautista	ENG	63	Marte S.Mjaatvedt	NOR
6	Dane De Klerk	AUS	35	Ayat Kellakh	FRA	64	Marthe Bjordal	NOR
7	Bruna Magalhães	BRA	36	Zoé Duvert	FRA	65	Krishna Sherpa	NPL
8	Raissa Barroso	BRA	37	Bethinn Wright	GBR	66	Inês Salgueiro	PRT
9	Natalie Demidova	CAN	38	Caitlin Gray	GBR	67	Aliia Mirgalimova	RUS
10	Katie Chin	CAN	39	Emma Eaton	GBR	68	Alina Chernysheva	RUS
11	Adele Wolske	CAN	40	Jodie Ferguson	GBR	69	Anastasiia Latosha	RUS
12	Celeste Wolske	CAN	41	Taylor Phipps	IRL	70	Diana Ananeva	RUS
13	Maya Slauson	CAN	42	Hazar Sadia	ISR	71	Elizaveta Volkova	RUS
14	Camila González	CHL	43	Rachel Slyusarevsky	ISR	72	Milana Riabova	RUS
15	Eileen Vargas	CHL	44	Roaya Saady	ISR	73	Marijana Milojkovic	SUI
16	Catalina Valdés	CHL	45	Wada Haldi	ISR	74	Sanne Dokter	SUI
17	Thiare Alvaez	CHL	46	Chiaki Shirai	JPN	75	Moa Schér	SWE
18	Francisca Guzmán	CHL	47	Honoka Yazawa	JPN	76	Ciara Stuhler	USA
19	Alice Andrlova	CZE	48	Kaede Kuga	JPN	77	Danielle Lovato	USA
20	Anezka Dolanska	CZE	49	Nana Asaoka	JPN	78	Emily Nagatomo	USA
21	Veronika Hruzova	CZE	50	Gaelle Rakotonindrina	MDG	79	Grace Marulanda	USA
22	Kristina Bosakova	CZE	51	Ianja Randrianasolo	MDG	80	Miranda Brengartner	USA
23	Anna Hirslova	CZE	52	Jessie Randrianasolo	MDG	81	Bianca Ridley	ZAF
24	Emily Bevier	DEU	53	Kanto Ramparison	MDG	82	Elmien Viljoen	ZAF
25	Katinka Ball	DEU	54	Kiadinirina Tiantsoa	MDG	83	Emma-Leigh Chisholm	ZAF
26	Laura Kellner	DEU	55	Vetsoniaina Nathalie	MDG	84	Johandri Du Toit	ZAF
27	Sabina Tusan	DEU	56	Aurora Rodriguez	MEX	85	Leanne Munro	ZAF
28	Victoria Eckert	DEU	57	Nora Cortes	MEX	86	Stella Van Niekerk	ZAF
29	Ceyda Kibar	DNK	58	Liane Chircop	MLT			



## Age 19-21 Girls

1	Ayelen Balista	ARG	18	Diana Pfister	DEU	35	Maren Aamodt	NOR
2	Rocio Vinet	ARG	19	Eblina Kelmendi	DEU	36	Alina Shakirova	RUS
3	Taneesha Gray	AUS	20	Eblina Kelmendi	DEU	37	Anastasiia Nazarkina	RUS
4	Emily Lew	AUS	21	Helena Pejic	DEU	38	Mariia Voronina	RUS
5	Tyler - Jane Carey	AUS	22	Leonie Diffené	DEU	39	Saniyat Rizakhanova	RUS
6	Elleigh Turner	AUS	23	Mahassen Jaffal	DEU	40	Veronika Bronnikova	RUS
7	Jordan Piscioneri	AUS	24	Sofia Kanamat	DNK	41	Alma Polozani	SUI
8	Lazrak Noussaïba	BEL	25	Charline Pelz ferry	FRA	42	Annalena Grenacher	SUI
9	Lorena Costa	BRA	26	Emese Berta	HUN	43	Drenusha Sejdijaj	SUI
10	Kauane Sgarbi	BRA	27	Réka Vass	HUN	44	Leoni Isenegger	SUI
11	Paula Jessica Silva	BRA	28	Valentina Váradi	HUN	45	Linn Elofsson	SWE
12	Diane Araujo	BRA	29	Kazusa Nagata	JPN	46	Sofie Palm	SWE
13	Luana Neves Santos	BRA	30	Noeru Hada	JPN	47	FAN KAI TING	TWN
14	Melody Hoghooghi	CAN	31	Assel AlOrbani	KWT	48	Alyssa Van Der Merwe	ZAF
15	Yasmine Solomon-Markus	CAN	32	Fatin Wasim	KWT	49	Boipelo Seabelo	ZAF
16	Sara-Leah Eisenberg	CAN	33	Lizeth Ruiz	MEX	50	Brittany Shepstone	ZAF
17	Susana Li	CHL	34	Nicole Chircop	MLT	51	Savannah Thompson	ZAF

## Women

1	Jeanette Castañeda	ARG	35	Joana Tsesmeles	DEU	69	Cécile Orrigo	MCO
2	Vanesa Chaves	ARG	36	Melissa Rathmann	DEU	70	Felana Ainamampionona	MDG
3	Lorena Sanchez	ARG	37	Michaela Rein	DEU	71	Lucía Becerril	MEX
4	Karina Parada	ARG	38	Nadja Stuchlik	DEU	72	Yadira Suarez	MEX
5	Sofia Siffo	ARG	39	Sara Baradaran	DEU	73	Michelle Jongen	NLD
6	Chane Brits	AUS	40	Sara Elgaard	DNK	74	Janette Hansen	NOR
7	Sam Sparkes	AUS	41	Gema Rodriguez	ENG	75	Delmira Bonilla	PAN
8	Sherridan Bower	AUS	42	Jana Sersnova	ENG	76	Yaremi Borzelli	PAN
9	Lana Rosenbaum	AUS	43	Rachel O'Halloran	ENG	77	Aleksandra Nedbai	RUS
10	Rena Moriguchi	AUS	44	Roisin Campbell	ENG	78	Daria Leushina	RUS
11	Kim Parker	AUS	45	Rose Tumminello	ENG	79	Ekaterina Kling	RUS
12	Evelyn Naessens	BEL	46	Mayra Rios Morales	ESP	80	Mariia Dauliatshina	RUS
13	Manuela Spessatto	BRA	47	Anne catherine Novak	FRA	81	Magali Brachat	SGP
14	Juliana Vitral	BRA	48	Marion Guinot	FRA	82	Naomi Ishibashi	SGP
15	Letícia Aragão	BRA	49	Jaclyn Carberry	GBR	83	Katarina Cesar	SVN
16	Martinna Rey	BRA	50	Karolina Marzenta	GBR	84	Annie Ydström	SWE
17	Cristiane Babinsky	BRA	51	Kylie Banard	GBR	85	Emelie Palm	SWE
18	Waabo Anwar	BWA	52	Monica Masowa	GBR	86	Linda Andersson	SWE
19	Lame Hetanang	BWA	53	Kitti Schvarcz	HUN	87	YANG, J-CHENG	TWN
20	Pascale Coggins	CAN	54	Livia Rancz	HUN	88	Abby Barrera	USA
21	Manon Quirion	CAN	55	Meida Tri Suhartati	IDN	89	Carolyn Rinaldi	USA
22	Leah Villanueva	CAN	56	Ashley Hill	IRL	90	Christina Foo	USA
23	Melinda Massotti	CAN	57	Meadhbh O Callghan	IRL	91	Madeline Mandragon	USA
24	Jing Guo	CHN	58	Denise Passerini	ITA	92	Rachel Kattawar	USA
25	Clara Martinez	COL	59	Marta Tranquillini	ITA	93	Ray Semana	USA
26	Paula Giraldo	COL	60	Tania Cavalera	ITA	94	Chanel Stevens	ZAF
27	Margarita Bustos	COL	61	Mai Shiina	JPN	95	Crystal Poulter	ZAF
28	Marie Prajzlerova	CZE	62	Yu Shiina	JPN	96	Elsabe Le Roux	ZAF
29	Karin Kosikova	CZE	63	Kyoko Akiyama	JPN	97	Gidea Pretorius	ZAF
30	Lucie Koppelova	CZE	64	Minori Amano	JPN	98	Priscilla Garvey	ZAF
31	Jarmila Masopustova	CZE	65	Ayano Nakamura	JPN	99	Priya Pillay	ZAF
32	Bianca Walsleben	DEU	66	Rio Hayakawa	JPN	100	Trisha Rajkumar	ZAF
33	Caroline Sieger	DEU	67	Yuna Sato	JPN	101	Emily Lombe	ZMB
34	Jeannette Bellhaeuser	DEU	68	Misaki Matsubara	JPN	102	Mwila Mwabi	ZMB

www.  
**CorkTrophyCentre**  
.com

Commercial Park, Link Road, Ballincollig, Co. Cork

**021 487 33 22**

corktrophycentre@gmail.com



*Window Cleaning / Power Washing*  
*Painting / Stainless Steel Polishing*  
*Oven Cleaning / Leather Cleaning*

*Competitive Rates & Reliable Service*

Contact Paul @ 087-8172782

# The Locke



## TRADITIONAL IRISH MUSIC AND IRISH DANCING

**7 NIGHTS A WEEK**

Limerick's oldest traditional Irish pub.  
Situated in the heart of Limerick's Medieval  
Quarter, within walking distance of Limerick's  
historical landmarks and attractions.

3 GEORGES QUAY, LIMERICK | (061) 413 733 | WWW.LOCKEBAR.COM

## Age 9 Boys Kata

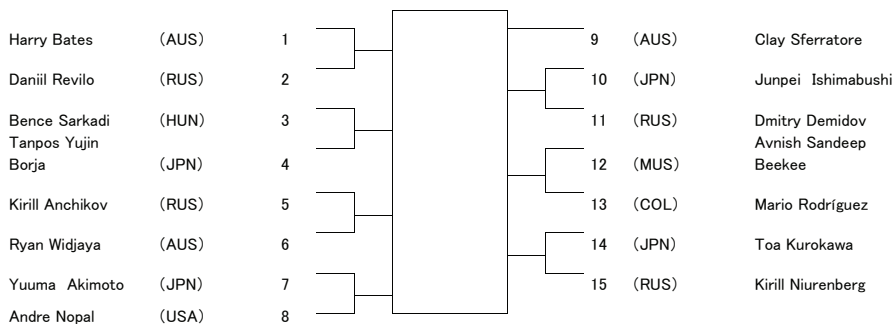

## Age 9 Boys Kumite

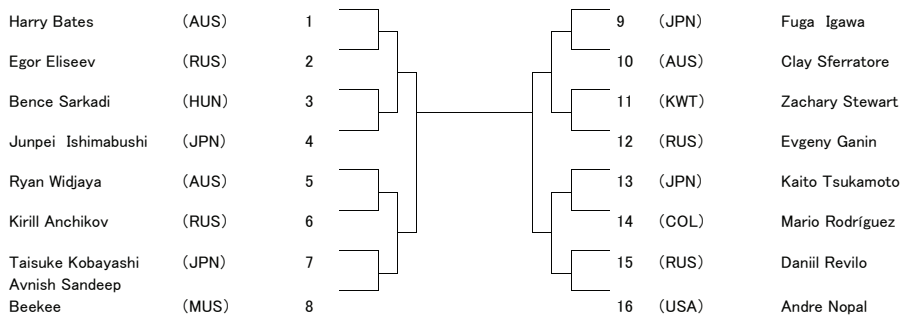

## Age 9 Girls Kata

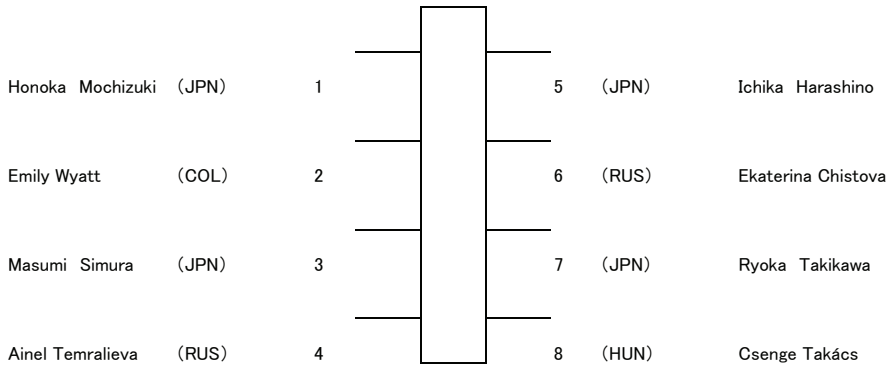

## Age 9 Girls Kumite

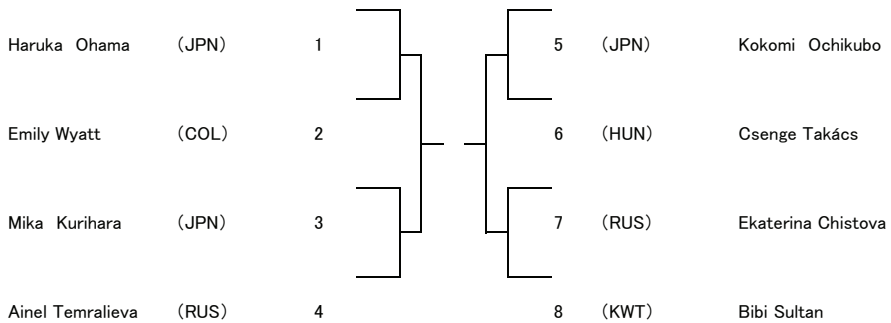

## Age 10 Boys Kata

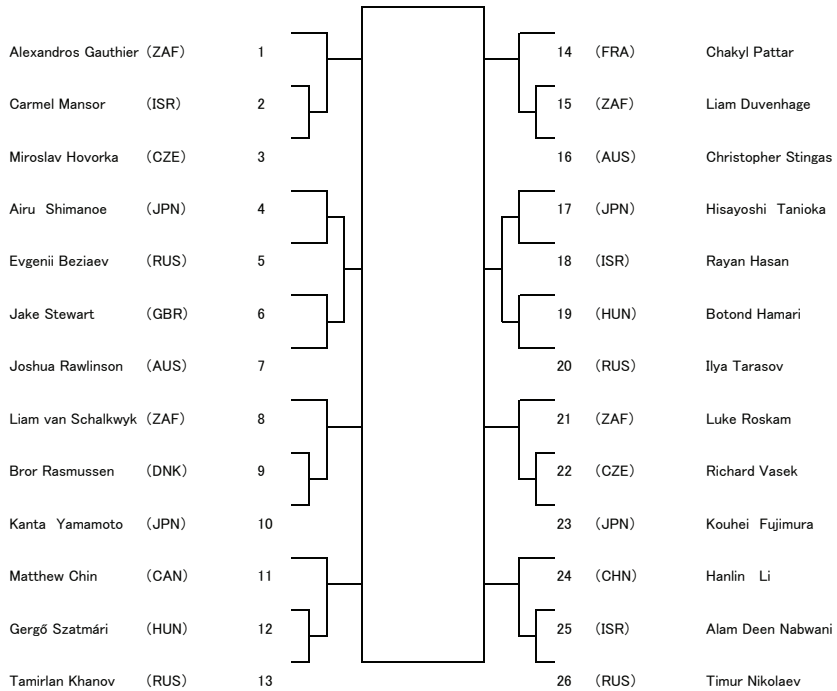

## Age 10 Boys Kumite

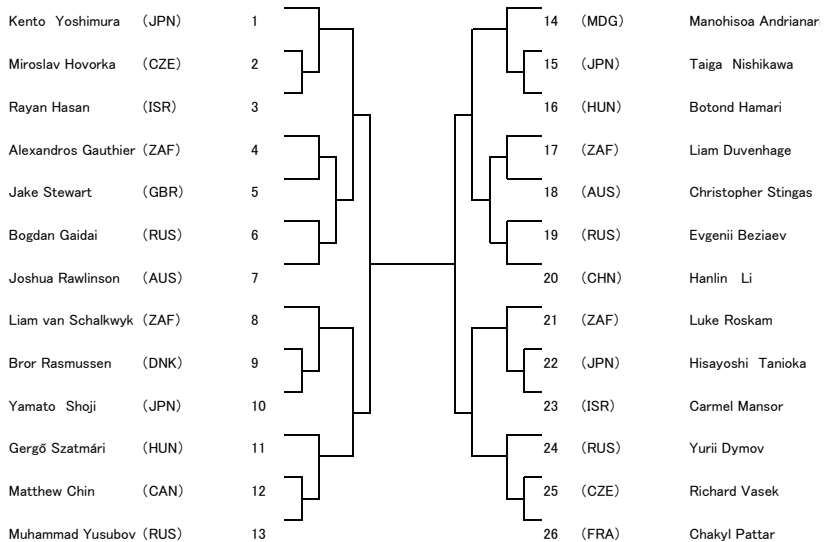

## Age 10 Girls Kata

Chloe Van Emmenis (AUS)	1		10 (RUS)	Anastasiia Diakonova
Alina Bekbulatova (RUS)	2		11 (CZE)	Helena Prechova
Mia Simonova (CZE)	3		12 (ZAF)	Elri van der Westhuizen
Akari Orito (JPN)	4		13 (JPN)	Akari Saito
Ashley Viljoen (ZAF)	5		14 (RUS)	Radmilla Namazbaeva
Anna Sheina (RUS)	6		15 (CZE)	Voktorie Maskova
Marie Dobsova (CZE)	7		16 (COL)	Sofia Wyatt
Sayaka Fujii (JPN)	8		17 (JPN)	Yuzuki Soken
Gabrielle Woest (ZAF)	9			

## Age 10 Girls Kumite

Mia Simonova (CZE)	1		10 (RUS)	Anna Sheina
Chloe Van Emmenis (AUS)	2		11 (CZE)	Helena Prechova
Alina Bekbulatova (RUS)	3		12 (ZAF)	Elri van der Westhuizen
Hiyori Koda (JPN)	4		13 (JPN)	Kokomi Ichiba
Ashley Viljoen (ZAF)	5		14 (CZE)	Voktorie Maskova
Ekaterina Shilkova (RUS)	6		15 (RUS)	Radmilla Namazbaeva
Marie Dobsova (CZE)	7		16 (JPN)	Narumi Hariya
Gabrielle Woest (ZAF)	8		17 (COL)	Sofia Wyatt
Maria Yasuda (JPN)	9			





## Age 11 Girls Kata

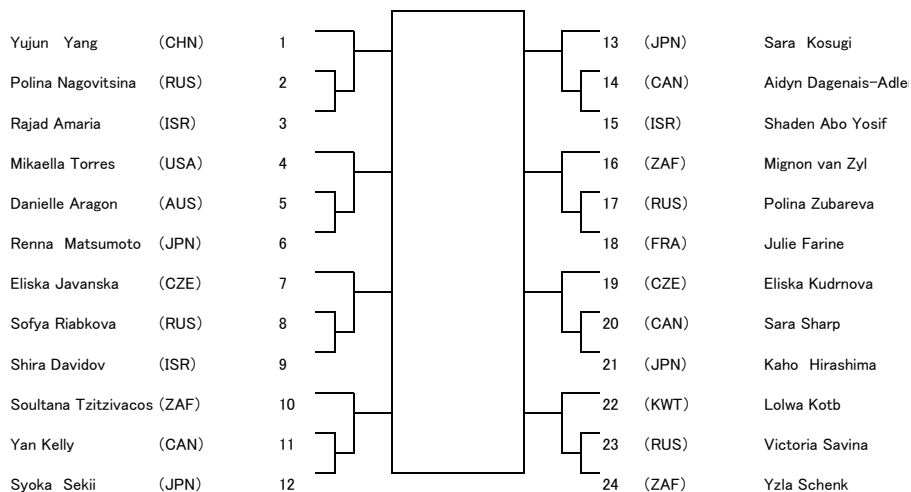

## Age 11 Girls Kumite

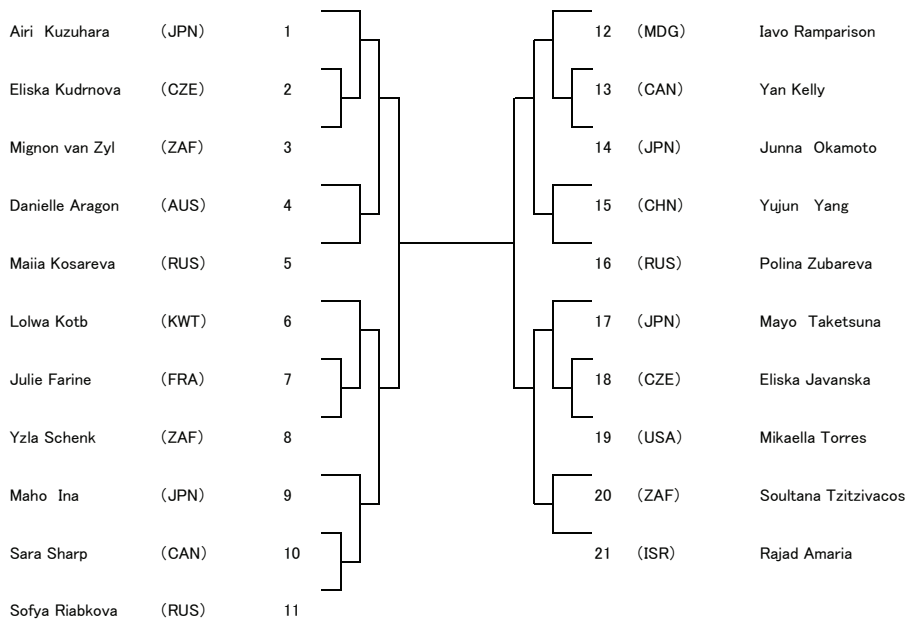

## Age 12 Boys Kata

Curtis Sproxtton	(AUS)	1		18	(CHL)	Cristopher Fernando;
Dmitriy Shlepov	(RUS)	2		19	(HUN)	Lőrincz Bednarik
Bálint Muhari	(HUN)	3		20	(RUS)	Georgy Pankov
Franco Gianluca	(ARG)	4		21	(UAE)	Mahmoud Maher
Muqsit Ali	(PAK)	5		22	(AUS)	Nathan Wilkinson
Hayato Satake	(JPN)	6		23	(CAN)	Darian Nasirzadeh
Connor Harris	(ZAF)	7		24	(ZAF)	Galaletsang Rathebe
Christopher Chin	(CAN)	8		25	(JPN)	Ryo Mizuta
Daniel Havlicek	(CZE)	9		26	(IND)	Janardan Deka
Timur Atazhanov	(RUS)	10		27	(BRA)	João Felipe Rosa
Máté Miskovitz	(HUN)	11		28	(RUS)	Aleksandr Maksimov
Raul Quijada	(CHL)	12		29	(AUS)	Jake Sferatore
Jack McCaughtrie	(AUS)	13		30	(HUN)	András Káldi
Khalid Zubidat	(ISR)	14		31	(CAN)	Jacob Pichhadze
Ryuunosuke Saito	(JPN)	15		32	(JPN)	Gousei Konishi
Tyson Cragg	(CAN)	16		33	(ZAF)	Tyj Purchase
Julio Bartolo	(ZAF)	17		34	(MDG)	Cedrick Mougín

## Age 12 Boys Kumite

Muqsit Ali	(PAK)	1		18	(HUN)	Attila Káldi
Attila Bihari	(HUN)	2		19	(UAE)	Mahmoud Maher
Curtis Sproxtton	(AUS)	3		20	(RUS)	Aleksandr Maksimov
Dmitrii Butaev	(RUS)	4		21	(AUS)	Nathan Wilkinson
Franco Gianluca	(ARG)	5		22	(CHL)	Cristopher Fernando;
Christopher Chin	(CAN)	6		23	(ZAF)	Connor Harris
Arjun Thulsie	(ZAF)	7		24	(JPN)	Rinya Ii
Koga Tamuro	(JPN)	8		25	(BRA)	João Felipe Rosa
Daniel Havlicek	(CZE)	9		26	(CAN)	Darian Nasirzadeh
Jack McCaughtrie	(AUS)	10		27	(RUS)	Gennadiy Malchushki
Roland Karakó	(HUN)	11		28	(HUN)	András Káldi
Ramil Gumiarov	(RUS)	12		29	(AUS)	Jake Sferatore
Raul Quijada	(CHL)	13		30	(ISR)	Khalid Zubidat
Tyson Cragg	(CAN)	14		31	(JPN)	Tarou Kouno
Takakiyo Iguchi	(JPN)	15		32	(ZAF)	PW Pentz
Jessam Khadraoui	(ZAF)	16		33	(CAN)	Jacob Pichhadze
Jamil Abo-Sada	(ISR)	17		34	(IND)	Janardan Deka

## Age 12 Girls Kata

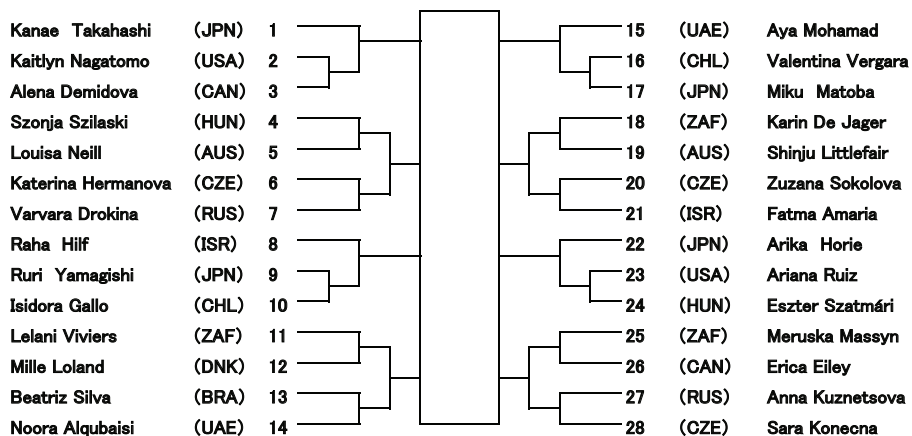

## Age 12 Girls Kumite

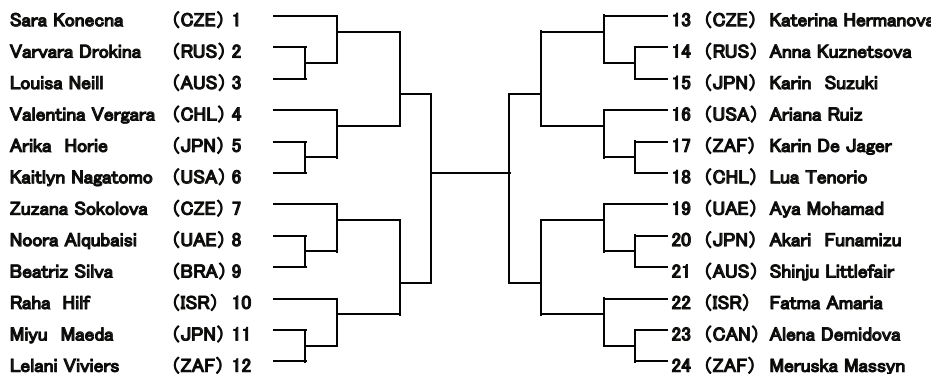

## Age 13 Boys Kata

Estiaan Cronje (ZAF)	1		25 (AUS)	Flynn Bushell
Atiya Omariyyah (ISR)	2		26 (CAN)	Shayan Hoghooghi
Amir Sharapov (RUS)	3		27 (ISR)	Eial Shomre
Kyle Bruce (GBR)	4		28 (KWT)	Abdulaziz Nayfeh
Lachlan Isles (AUS)	5		29 (ZAF)	Ruan Cronje
Louis Adrar (CAN)	6		30 (CZE)	Pavel Pospisil
ABDEL RAHMAN Fat (UAE)	7		31 (HUN)	Gábor Barki
Julien Derosiaux (FRA)	8		32 (UAE)	Ali Mohamad
Mitozo Andrianaho (MDG)	9		33 (CHL)	José D. Suarez
Kouki Yamazaki (JPN)	10		34 (BRA)	João Pedro Hioki
Juan Felipe Vargas (COL)	11		35 (SGP)	Eisuke Murakoshi
Daniel Morais Kunz (BRA)	12		36 (JPN)	Sena Naito
Adam Nunvar (CAN)	13		37 (ZAF)	Deigo Watson
Rodi Lelawi (ISR)	14		38 (MUS)	Teiva Samfat
Deen Selmanovic (AUS)	15		39 (FRA)	Mark Chapier
Xavier Strydom (ZAF)	16		40 (GBR)	Dylan Buckley
Gábor Máté (HUN)	17		41 (ISR)	Yousef Daher
Vladislav Kostiuokov (RUS)	18		42 (AUS)	Bashtion Littlefair
Saad Ali (UAE)	19		43 (HUN)	Máté Jele
Syoma Hatanaka (JPN)	20		44 (BRA)	Pedro Feuerharnael
Maxim Simon (CZE)	21		45 (UAE)	Youssef Ibrahim
Luis André Alencastr (BRA)	22		46 (DNK)	Tobias Lindbock
Samy Sadoudi (FRA)	23		47 (RUS)	Ivan Latkin
David Matutis (USA)	24			

## Age 13 Boys Kumite

Lachlan Isles (AUS)	1		24 (JPN)	Kosuke Nagatsuka
Aleksandr Toropov (RUS)	2		25 (AUS)	Deen Selmanovic
Louis Adrar (CAN)	3		26 (GBR)	Lewis Simpson
Kyle Bruce (GBR)	4		27 (UAE)	Ali Mohamad
Carl Van Niekerk (ZAF)	5		28 (ISR)	Eial Shomre
Atiya Omariyyah (ISR)	6		29 (KWT)	Abdulaziz Nayfeh
Saad Ali (UAE)	7		30 (BRA)	João Pedro Hioki
Daniel Morais Kunz (BRA)	8		31 (CHL)	José D. Suarez
Kaito Ishii (JPN)	9		32 (ZAF)	Estiaan Cronje
Julien Derosiaux (FRA)	10		33 (RUS)	Leonard Khomiakov
David Matutis (USA)	11		34 (CAN)	Adam Nunvar
ABDEL RAHMAN Fat (UAE)	12		35 (ISR)	Yousef Daher
Mitozo Andrianaho (MDG)	13		36 (MUS)	Teiva Samfat
Rodi Lelawi (ISR)	14		37 (AUS)	Joseph Stoneman
Kaden Renwick (AUS)	15		38 (GBR)	Blair Flynn
Aiden Walsh (CAN)	16		39 (UAE)	Youssef Ibrahim
Ruan Cronje (ZAF)	17		40 (CZE)	Pavel Pospisil
Semen Kutiaшов (RUS)	18		41 (RUS)	Sergei Mutovkin
Samy Sadoudi (FRA)	19		42 (DNK)	Tobias Lindbock
Sena Naito (JPN)	20		43 (ZAF)	Callum Haskell
Maxim Simon (CZE)	21		44 (FRA)	Mark Chapier
Juan Felipe Vargas (COL)	22		45 (BRA)	Pedro Feuerharnael
Luis André Alencastr (BRA)	23			

## Age 13 Girls Kata

Camila Martinez (ARG)	1		15 (JPN)	Airi Sekizawa
Anna Kaiser (HUN)	2		16 (CAN)	Ophelie Darche
Anna Beliaeva (RUS)	3		17 (AUS)	Jacinta Mudie
Monika Brucknerova (CZE)	4		18 (NLD)	Natalia Breidenbach
Airi Takikawa (JPN)	5		19 (DNK)	Isabelle M. Tissot
Alexi Frick (ZAF)	6		20 (CZE)	Sara Ferencova
Eliana Eisenberg (CAN)	7		21 (ZAF)	Lara Van Rensburg
Adela Matouskova (CZE)	8		22 (JPN)	Karen Imatomi
Diana Korepanova (RUS)	9		23 (AUS)	Emielia Jansen
Natalia Lopez (MEX)	10		24 (USA)	Yuki Hoshi
Jamie Bridgeman (AUS)	11		25 (GBR)	Lia McLaren
Rimi Ina (JPN)	12		26 (MDG)	Brenda Rakotomalala
Michaela Herbert (ZAF)	13		27 (RUS)	Daria Bogdanova
Amy McInally (GBR)	14		28 (ZAF)	Monique Van Der Me

## Age 13 Girls Kumite

Monika Brucknerova (CZE)	1		13 (ZAF)	Lara Van Rensburg
Camila Martinez (ARG)	2		14 (JPN)	Mimi Beppu
Anna Beliaeva (RUS)	3		15 (CZE)	Sara Ferencova
Hina Sakai (JPN)	4		16 (MEX)	Natalia Lopez
Eliana Eisenberg (CAN)	5		17 (RUS)	Bogdana Vorchik
Alexi Frick (ZAF)	6		18 (AUS)	Jacinta Mudie
Jamie Bridgeman (AUS)	7		19 (JPN)	Aoi Fukuda
Daria Bogdanova (RUS)	8		20 (CAN)	Ophelie Darche
Adela Matouskova (CZE)	9		21 (ZAF)	Wilmari Olivier
Omoto Yokosaka (JPN)	10		22 (AUS)	Emielia Jansen
Monique Van Der Me (ZAF)	11		23 (RUS)	Aleksandra Basovska
Natalia Breidenbach (NLD)	12		24 (USA)	Yuki Hoshi

## Age 14 Boys Kata

Khayden Cesar-Mohz (CAN)	1		26 (DEU)	Tomm Janik
Joaquin Calbello (ARG)	2		27 (BRA)	Miguel Cumeira
Iliia Pavlov (RUS)	3		28 (JPN)	Ryohei Yuge
Benjamin Farris (USA)	4		29 (ZAF)	Anthony van der Wat
Bodhi Gallagher (AUS)	5		30 (CHL)	Nicolás Gómez
Kamal Fares (ISR)	6		31 (CZE)	Filip Konecny
Attila Baumann (HUN)	7		32 (ISR)	Omer Friedlander
Diogo Domingues (BRA)	8		33 (HUN)	Kristóf Czibolya
Valentini Randriambo (MDG)	9		34 (CAN)	Harley Eiley
Ryo Iwabuchi (JPN)	10		35 (MEX)	Jose Medina
Bertram Kvist (DNK)	11		36 (AUS)	Ryan Daly
Darian Booysen (ZAF)	12		37 (RUS)	Nikita Eliseev
Ondrej Bosak (CZE)	13		38 (CZE)	Tobias Suchanek
Tal Vaisman (ISR)	14		39 (FRA)	Khamzat Muanev
Liam Mc Carthy (IRL)	15		40 (ZAF)	Kieran Stadler
Nikolai Astakhov (RUS)	16		41 (BRA)	Rodolfo Figueiredo
Bruno Vogel (DEU)	17		42 (ENG)	Tosan Awani
Ali Afrasiabi (CAN)	18		43 (JPN)	Kenshiro Sato
Cole Waite (AUS)	19		44 (PAN)	Mikel Diaz
Taisei Koga (JPN)	20		45 (ARG)	Antonio Castañeira
Stefan Kluivers (NLD)	21		46 (MDG)	Tokiniaina Razafindra
Kenji Escribe (FRA)	22		47 (RUS)	Timofei Fazly
Martin Prech (CZE)	23		48 (ISR)	Amit Davidov
Luigi Ferraro (BRA)	24		49 (CAN)	Andy Phok
Tristan Clark (ZAF)	25			

## Age 14 Boys Kumite

Callum Flynn (GBR)	1		24 (RUS)	Daniia Mashchenko
Joaquin Calbello (ARG)	2		25 (BRA)	Miguel Cumeira
Bodhi Gallagher (AUS)	3		26 (ENG)	Tosan Awani
Khayden Cesar-Mohz (CAN)	4		27 (HUN)	Attila Baumann
Mikel Diaz (PAN)	5		28 (ARG)	Antonio Castañeira
Gin Takahashi (JPN)	6		29 (CZE)	Filip Konecny
Bertram Kvist (DNK)	7		30 (ISR)	Kamal Fares
Lucas Thornton (IRL)	8		31 (ZAF)	Anthony van der Wat
Diogo Domingues (BRA)	9		32 (FRA)	Khamzat Muanev
Benjamin Farris (USA)	10		33 (AUS)	Ryan Daly
Ondrej Bosak (CZE)	11		34 (CAN)	Harley Eiley
Cameron Varga (ZAF)	12		35 (MEX)	Jose Medina
Cole Waite (AUS)	13		36 (BRA)	Rodolfo Figueiredo
Iurii Gutenko (RUS)	14		37 (CZE)	Tobias Suchanek
Bruno Vogel (DEU)	15		38 (DEU)	Tomm Janik
Dominik Stum (HUN)	16		39 (RUS)	Nikita Medonii
Ali Afrasiabi (CAN)	17		40 (HUN)	Kristóf Czibolya
Yusei Suetake (JPN)	18		41 (ZAF)	Darian Booysen
Omer Friedlander (ISR)	19		42 (CHL)	Nicolás Gómez
Luigi Ferraro (BRA)	20		43 (JPN)	Yamato Satou
Kenji Escribe (FRA)	21		44 (CAN)	Andy Phok
Martin Prech (CZE)	22		45 (ISR)	Tal Vaisman
Shrimay Manilal (ZAF)	23			

## Age 14 Girls Kata

Beate Van Der Linde (ZAF)	1		18 (UAE)	Nadein Mohamad
Carmen Rojas (USA)	2		19 (RUS)	Liliia Korotkaia
Lucy Hull (GBR)	3		20 (DEU)	Victoria Hau Eisen
Aneta Zitkova (CZE)	4		21 (JPN)	Kotoha Komai
Tara Daly (AUS)	5		22 (AUS)	Makenzie Rowe
Karin Sato (JPN)	6		23 (USA)	Teresita Salas
Glafira Aleinik (RUS)	7		24 (HUN)	Rebeka Szalai
Manuela Simão Coelh (BRA)	8		25 (ZAF)	Drew Townley
Alma Sabalich (ARG)	9		26 (BRA)	Ana Paula Sukiennik
Georgina Waser (AUS)	10		27 (JPN)	Haruna Suzuki
Sahar Shkhedem (ISR)	11		28 (ARG)	Guillermina Fitz Maur
Michaela Soukupova (CZE)	12		29 (AUS)	Zoe Garifallou
Jaydene Naidoo (ZAF)	13		30 (ENG)	Mia Lam
Margarita Bekbulatov (RUS)	14		31 (CZE)	Nikola Melicharova
Lea B. Nielsen (DNK)	15		32 (NLD)	Dayna Slangen
Houtashna Sembhoo (MUS)	16		33 (ZAF)	Yayra Ankude
Ismaya Moraes (BRA)	17		34 (CHN)	Emily Jiang

## Age 14 Girls Kumite

Alma Sabalich (ARG)	1		17 (ENG)	Mia Lam
Tara Daly (AUS)	2		18 (CZE)	Aneta Zitkova
Victoria Hau Eisen (DEU)	3		19 (ARG)	Guillermina Fitz Maur
Houtashna Sembhoo (MUS)	4		20 (AUS)	Makenzie Rowe
Sahar Shkhedem (ISR)	5		21 (JPN)	Kokoro Shintani
Drew Townley (ZAF)	6		22 (RUS)	Viktorria Miakota
Emily Jiang (CHN)	7		23 (NLD)	Dayna Slangen
Nadein Mohamad (UAE)	8		24 (ZAF)	Jaydene Naidoo
Lucy Hull (GBR)	9		25 (HUN)	Rebeka Szalai
Georgina Waser (AUS)	10		26 (AUS)	Zoe Garifallou
Manuela Simão Coelh (BRA)	11		27 (BRA)	Ismaya Moraes
Liliia Korotkaia (RUS)	12		28 (CZE)	Michaela Soukupova
Nikola Melicharova (CZE)	13		29 (ZAF)	Beate Van Der Linde
Yayra Ankude (ZAF)	14		30 (USA)	Carmen Rojas
Nanami Hyuga (JPN)	15		31 (JPN)	Kajitsu Sakata
Teresita Salas (USA)	16			



## Age 15 Boys Kata

Andru Teece	(CAN)	1		22	(JPN)	Naruya Hashimoto
Ostap Pushkov	(RUS)	2		23	(USA)	Kim Torres
Daniel Class	(ZAF)	3		24	(MDG)	Mami Mick Ravelosor
Brae Wagner	(AUS)	4		25	(CAN)	Angelo Reoligio
Kohei Sedaka	(JPN)	5		26	(SUI)	Kron Osmani
Muhammad Adriel Ha	(IDN)	6		27	(HUN)	Csongor Berta
Franco Jacquet	(ARG)	7		28	(AUS)	Lucas Decker
Adrian Bosse	(DEU)	8		29	(ZAF)	Jayden Weaver
Adam Kriz	(CZE)	9		30	(BRA)	Rondon Caiado
Dylan Rabary	(MDG)	10		31	(RUS)	Petr Pershin
August Tierney	(USA)	11		32	(FRA)	Erwyn Pattar
Kane Briggs	(AUS)	12		33	(CAN)	Ariel Crisostomo
Jaime Gómez	(CHL)	13		34	(JPN)	Kaishin Watanabe
Vadim Kuklin	(RUS)	14		35	(ARG)	Pehuen Naranjo
Soichiro Yoshida	(JPN)	15		36	(CHN)	Jun'an Li
Rorisang Mookane	(ZAF)	16		37	(USA)	Tino Damiani
Ádám Veress	(HUN)	17		38	(RUS)	Maksim Gabov
Timothy Rinaldi	(USA)	18		39	(DEU)	Arthur Keller
Minh Doan	(DEU)	19		40	(ZAF)	Therín-John de Meyer
Raul Rocha	(BRA)	20		41	(LKA)	Mohamed Shuaib Raf
Toavina Rakotovao	(MDG)	21		42	(CZE)	Simon Lev

## Age 15 Boys Kumite

Aleksandr Danilov	(RUS)	1		23	(LKA)	Mohamed Shuaib Raf
Hendrik Smits	(ZAF)	2		24	(CZE)	Simon Lev
Muhammad Adriel Ha	(IDN)	3		25	(RUS)	Denis Bobrov
Andru Teece	(CAN)	4		26	(JPN)	Kanta Ootsu
Rekka Aizawa	(JPN)	5		27	(ARG)	Pehuen Naranjo
Brae Wagner	(AUS)	6		28	(ZAF)	Rorisang Mookane
Kim Torres	(USA)	7		29	(MDG)	Kiady Ramparison
Adrian Bosse	(DEU)	8		30	(CHN)	Jun'an Li
Dylan Rabary	(MDG)	9		31	(AUS)	Lucas Decker
Adam Kriz	(CZE)	10		32	(USA)	Timothy Rinaldi
Franco Jacquet	(ARG)	11		33	(CAN)	Ariel Crisostomo
Kane Briggs	(AUS)	12		34	(JPN)	Sora Soma
Therín-John de Meyer	(ZAF)	13		35	(ZAF)	Daniel Class
Diego Casas	(CHL)	14		36	(BRA)	Rondon Caiado
Toki Inada	(JPN)	15		37	(RUS)	Vladimir Semchishin
Victor Fomiryakov	(RUS)	16		38	(HUN)	Richárd Ugró
Kron Osmani	(SUI)	17		39	(DEU)	Arthur Keller
Raul Rocha	(BRA)	18		40	(FRA)	Erwyn Pattar
Csongor Berta	(HUN)	19		41	(USA)	August Tierney
Minh Doan	(DEU)	20		42	(CHL)	Jaime Gómez
Mami Mick Ravelosor	(MDG)	21		43	(MDG)	Toavina Rakotovao
Tino Damiani	(USA)	22				

## Age 15 Girls Kata

Audrey-Ann Rioux (CAN)	1		18 (USA)	Yana Weng
Ana Luisa Venito (BRA)	2		19 (DEU)	Luisa Schlien
Iona Barclay (GBR)	3		20 (RUS)	Diana Palchikova
Evelyn Mtetwa (ZAF)	4		21 (CAN)	Eden Duffy
Sammi Yeung (USA)	5		22 (AUS)	Rosey Cameron
Aluen Paz Dovis (ARG)	6		23 (ZAF)	Gabriella Alessandri
Celina Kreutz (DEU)	7		24 (JPN)	Yumine Fujisawa
Maaike Weijl (NLD)	8		25 (ENG)	Tia Molesbury
Anna Vajoda (HUN)	9		26 (HUN)	Janka Groh
Cali Dixon (CAN)	10		27 (AUS)	Felicity Gersbach
Kokoro Kanezaki (JPN)	11		28 (CAN)	Sara Hughes
Romy Nathan (ZAF)	12		29 (CHL)	Kimmy Vega
Adela Jiraskova (CZE)	13		30 (GBR)	Lucy Ferguson
Ciarah Shandiman (AUS)	14		31 (CZE)	Kristyna Tesarova
Alberte Olsen (DNK)	15		32 (ISR)	Rekan Khaldy
Charlotte Anfinssen (NOR)	16		33 (NLD)	Paloma Weweng kang
Réka Pintér (HUN)	17		34 (ZAF)	Zoe Junge

## Age 15 Girls Kumite

Iona Barclay (GBR)	1		19 (NOR)	Charlotte Anfinssen
Audrey-Ann Rioux (CAN)	2		20 (NLD)	Maaike Weijl
Paloma Weweng kang (NLD)	3		21 (CAN)	Eden Duffy
Gabriella Alessandri (ZAF)	4		22 (AUS)	Rosey Cameron
Ana Luisa Venito (BRA)	5		23 (RUS)	Diana Palchikova
Celina Kreutz (DEU)	6		24 (CHL)	Kimmy Vega
Aleksandra Filatova (RUS)	7		25 (JPN)	Sawane Nishimoto
Saki Nakayama (JPN)	8		26 (DEU)	Luisa Schlien
Aluen Paz Dovis (ARG)	9		27 (ZAF)	Matuschka De Jager
Sammi Yeung (USA)	10		28 (CAN)	Sara Hughes
Cali Dixon (CAN)	11		29 (CZE)	Kristyna Tesarova
Rekan Khaldy (ISR)	12		30 (USA)	Yana Weng
Micaela Palmer (ZAF)	13		31 (SUI)	Seline Bagderelli
Adela Jiraskova (CZE)	14		32 (AUS)	Felicity Gersbach
Ciarah Shandiman (AUS)	15		33 (GBR)	Lucy Ferguson
Franciska Sprok (KWT)	16		34 (ENG)	Tia Molesbury
Nika Prusova (RUS)	17		35 (ZAF)	Romy Nathan
Mille Illum Oldenburg (DNK)	18		36 (JPN)	Saki Hirano

## Age 16-18 Boys Kata

Camilo de la Vega (MEX)	1		34 (CHL)	Hector Tapia
Granados Leopoldo (CAN)	2		35 (MUS)	Dhirendra Sembhoo
Zohar Ben Yishay (ISR)	3		36 (AUS)	Aaron Wairon
Gerard Felipe (AUS)	4		37 (CAN)	Joshua Basilan
Leandro Dias (PRT)	5		38 (DEU)	Roman Dinh
Bence Szlávik (HUN)	6		39 (JPN)	Ishin Kitazawa
Syed Tauhid Bukhari (DNK)	7		40 (USA)	Michael Umayam
Daniel Matousek (CZE)	8		41 (DNK)	Marcus Lindbock
Chadwin Deysel (ZAF)	9		42 (ZAF)	Shaugne van der Watt
Kenzo Lambert (FRA)	10		43 (MDG)	Ando Rakotoniaina
Enzo Pantoja (BRA)	11		44 (CZE)	Daniel Benes
Nikita Belovoshchev (RUS)	12		45 (GBR)	Calvin Bruce
Osama AlMohamad (KWT)	13		46 (BRA)	Thomaz Frassá
Paul Bosse (DEU)	14		47 (RUS)	Daniil Subbotin
Yerko Mella (CHL)	15		48 (IDN)	Axel Hendy Putra
Ole Even Refnes (NOR)	16		49 (ENG)	Alfie Cunningham
Facundo Burgos (ARG)	17		50 (ARG)	Facundo Tejerina
Masaya Tokuda (JPN)	18		51 (PRT)	Filipe Moniz
Pavel Zach (CZE)	19		52 (FRA)	Romain Gatoux
Omar Selmanovic (AUS)	20		53 (AUS)	Lachlan Fenton
Máté Kovács (HUN)	21		54 (JPN)	Takahiro Kanamori
Aumeeruddeen Allybocus (MUS)	22		55 (CAN)	Adrian Reyes
Thabiso Ramalitsi (ZAF)	23		56 (ZAF)	Zander Human
Shelby Gingras (CAN)	24		57 (HUN)	Martin Pászti
Cian Moroney (ENG)	25		58 (DEU)	Luca Di Fazio
Lucas Venito (BRA)	26		59 (MDG)	Mario Andrianimanana
Blair Wighton (GBR)	27		60 (BEL)	Yohan Raveydtts
Brandon Rakotomalala (MDG)	28		61 (RUS)	Sergei Gudkov
Tim Burkhardt (DEU)	29		62 (ENG)	Endri Krasniqi
Diego Castillo (PAN)	30		63 (NZL)	Ken Hanyu
Sviatoslav Pokrovskii (RUS)	31		64 (BRA)	Daniilo Cals
Franco Briones (CHL)	32		65 (MEX)	Juan Medina
Nikita Buchinskiy (BEL)	33		66 (CZE)	Tomas Hana

## Age 16-18 Boys Kumite

Facundo Burgos (ARG)	1		34 (AUS)	Omar Selmanovic
Aumeeruddeen Allybocus (MUS)	2		35 (CAN)	Shelby Gingras
Gerard Felipe (AUS)	3		36 (ZAF)	Chadwin Deysel
Alfie Cunningham (ENG)	4		37 (GBR)	Daniel Simpson
Michael Umayam (USA)	5		38 (JPN)	Takeru Kurita
Calvin Bruce (GBR)	6		39 (DEU)	Tim Burkhardt
Pavel Zach (CZE)	7		40 (HUN)	Máté Kovács
Karim Salimgareev (RUS)	8		41 (MEX)	Juan Medina
Granados Leopoldo (CAN)	9		42 (BRA)	Lucas Venito
Enzo Pantoja (BRA)	10		43 (PAN)	Diego Castillo
Axel Hendy Putra (IDN)	11		44 (DNK)	Syed Tauhid Bukhari
Luke Mills (ZAF)	12		45 (CHL)	Hector Tapia
Roman Dinh (DEU)	13		46 (RUS)	Kirill Kuznetsov
Noor Kanamat (DNK)	14		47 (BEL)	Yohan Raveydtts
Hashim Ambusaidi (OMN)	15		48 (ISR)	Zohar Ben Yishay
Ryosuke Jinnai (JPN)	16		49 (CZE)	Oliver Simon
Yerko Mella (CHL)	17		50 (GBR)	Blair Wighton
Coenraad Van Wyke (AUS)	18		51 (ARG)	Facundo Tejerina
Nikita Buchinskiy (BEL)	19		52 (ZAF)	Shaugne van der Watt
Endri Krasniqi (ENG)	20		53 (AUS)	Ricardo Hadfield
Peter Ihaza (CAN)	21		54 (CAN)	Mario Biscotti
Ole Even Refnes (NOR)	22		55 (DEU)	Paul Bosse
Nikita Belovoshchev (RUS)	23		56 (NZL)	Ken Hanyu
Marton Lozsi (CZE)	24		57 (MUS)	Dhirendra Sembhoo
Bence Szlávik (HUN)	25		58 (ENG)	Cian Moroney
Thabiso Ramalitsi (ZAF)	26		59 (BRA)	Piasky Simões
Bernardo Barreto (BRA)	27		60 (KWT)	Osama AlMohamad
Franco Briones (CHL)	28		61 (SUI)	Marc Reinbold
Filipe Moniz (PRT)	29		62 (RUS)	Dmitry Didenko
Romain Gatoux (FRA)	30		63 (CZE)	Tomas Hana
Brandon Rakotomalala (MDG)	31		64 (FRA)	Kenzo Lambert
Tom Priebernig (DEU)	32		65 (DNK)	Marcus Lindbock
Takumi Hasegawa (JPN)	33			





## Age 19-21 Girls kata

Fatin Wasim	(KWT)	1		18 (ZAF)	Alyssa Van Der Merwe
Taneesha Gray	(AUS)	2		19 (AUS)	Emily Lew
FAN KAI TING	(TWN)	3		20 (SUI)	Annalena Grenacher
Boipelo Seabelo	(ZAF)	4		21 (ARG)	Rocio Vinet
Yasmine Solomon-Markus	(CAN)	5		22 (BRA)	Paula Jessica Silva
Charline Pelz ferry	(FRA)	6		23 (CAN)	Sara-Leah Eisenberg
Kauane Sgarbi	(BRA)	7		24 (JPN)	Kazusa Nagata
Veronika Bronnikova	(RUS)	8		25 (NOR)	Maren Aamodt
Ayelen Balista	(ARG)	9		26 (DEU)	Leonie Diffené
Eblina Kelmendi	(DEU)	10		27 (MEX)	Lizeth Ruiz
Tyler – Jane Carey	(AUS)	11		28 (AUS)	Elleigh Turner
Nicole Chircop	(MLT)	12		29 (ZAF)	Brittany Shepstone
Savannah Thompson	(ZAF)	13		30 (BRA)	Lorena Costa
Luana Neves Santos	(BRA)	14		31 (SWE)	Linn Elofsson
Lazrak Noussaïba	(BEL)	15		32 (CAN)	Melody Hoghoghi
Leoni Isenegger	(SUI)	16		33 (KWT)	Assel AlOrbani
Noeru Hada	(JPN)	17			

## Age 19-21 Girls Kumite

Diana Pfister	(DEU)	1		21 (DEU)	Eblina Kelmendi
Fatin Wasim	(KWT)	2		22 (HUN)	Réka Vass
Anastasïia Nazarkina	(RUS)	3		23 (AUS)	Emily Lew
Taneesha Gray	(AUS)	4		24 (CHL)	Susana Li
Ayelen Balista	(ARG)	5		25 (ZAF)	Boipelo Seabelo
Sara-Leah Eisenberg	(CAN)	6		26 (MEX)	Lizeth Ruiz
Drenusha Sejdijaj	(SUI)	7		27 (RUS)	Mariia Voronina
Emese Berta	(HUN)	8		28 (BRA)	Diane Araujo
Kauane Sgarbi	(BRA)	9		29 (CAN)	Yasmine Solomon-Markus
Alyssa Van Der Merw	(ZAF)	10		30 (SUI)	Leoni Isenegger
Saniyat Rizakhanova	(RUS)	11		31 (ZAF)	Savannah Thompson
Helena Pejicic	(DEU)	12		32 (DEU)	Mahassen Jaffal
Maren Aamodt	(NOR)	13		33 (FRA)	Charline Pelz ferry
Tyler – Jane Carey	(AUS)	14		34 (AUS)	Jordan Piscioneri
Lazrak Noussaïba	(BEL)	15		35 (ARG)	Rocio Vinet
Luana Neves Santos	(BRA)	16		36 (TWN)	FAN KAI TING
Valentina Váradi	(HUN)	17		37 (RUS)	Alina Shakirova
Brittany Shepstone	(ZAF)	18		38 (KWT)	Assel AlOrbani
Sofia Kanamat	(DNK)	19		39 (SUI)	Alma Polozani
Sofie Palm	(SWE)	20		40 (BRA)	Lorena Costa



# Men Kumite

Jayme Sandall (BRA)	1					63 (ENG)	Mensah Oteh
Aleksandr Avvakumov (RUS)	2					64 (CHL)	Camilo Sandoval
Kens Cazeau (HTI)	3					65 (SWE)	Andreas Schliker A.
Goran Milovanović (SVN)	4					66 (SVN)	Florjan Reiter
Cameron Sparkes (AUS)	5					67 (HTI)	Evens Joiseus Nader
Dimitri Papadopoulos (USA)	6					68 (BRA)	Frank Manera
Binod Maharjan (NPL)	7					69 (MCO)	Florent Carpentier
Edoardo Barzaghi (ITA)	8					70 (GBR)	Colin Flynn
Kelvin Yamboto (ZMB)	9					71 (MEX)	Jose Negrete
Daniel Arceo (MEX)	10					72 (GZE)	Josef Pacovsky
Szabolcs Németh (HUN)	11					73 (NOR)	Anh Le Phan Thai
Jimmy Bernard (MCO)	12					74 (TWN)	Ken Hua Shang
Marek Babor (CZE)	13					75 (ZAF)	Sandile Makwali
Mauro Fuentes (CHL)	14					76 (AUS)	Edhem Kadic
Marcelo Monzon (ARG)	15					77 (ITA)	Fabrizio Curcuraci
George Draganov (ENG)	16					78 (ARG)	Ramon Aguirre
Thusara Gallage (BHR)	17					79 (ISR)	Amir Malak
Billy Ralainambinina (MDG)	18					80 (FRA)	Paul De vilepin
Tobias Schmidt (NLD)	19					81 (CAN)	Paul Atkin
Daniel Vogel (SWE)	20					82 (ZMB)	Robert Chisanga
Yasunori Okada (JPN)	21					83 (KWT)	Abdullah Barakat
Daniel Wessendorf (DEU)	22					84 (MDG)	Patrick Rjajaharitiana
Brian Nguyen (CAN)	23					85 (JPN)	Yusuke Haga
Cedric Pissis (FRA)	24					86 (RUS)	Arsen Baikhadzhiev
Nasrullah (PAK)	25					87 (PAN)	Josue Ramos
Arnaud Vicaire (BEL)	26					88 (HUN)	Zsolt Habda
MIGUEL CASTRODE (ESP)	27					89 (PAK)	Hussain Ali Changezi
Michael Thompson (ZAF)	28					90 (USA)	Jovani Marulanda
Carlos Santos (PAN)	29					91 (BEL)	Kristof Vermuelen
Artyom Vanesyan (ARM)	30					92 (ARM)	Sevak Hakobyan
Barry Tapster (IRL)	31					93 (DEU)	Dustin Deissler
Rafael Moreira (BRA)	32					94 (MEX)	Nicolas Cardona
Stefano De Bartolom (ITA)	33					95 (NOR)	Hans Andre Skaatun
Jorge Rivas (ARG)	34					96 (AUS)	Nurija Kadic
Fedlyn Joseph (HTI)	35					97 (ESP)	MIGUEL ANGEL LAS
Mohamed Alkindi (OMN)	36					98 (IRL)	Martin Cadwell
Karim Agrebi (MCO)	37					99 (CHL)	Rodrigo Rojas
Miguel Garibay (MEX)	38					100 (GBR)	Nick MacKay
Khim Torres (USA)	39					101 (ZAF)	Lorenzo Helena
Julio Silva (CHL)	40					102 (MCO)	Xavier Grammatico
Jacob T. Nissen (DNK)	41					103 (CYP)	Andreas Louca
Inal Khatkov (RUS)	42					104 (ENG)	Tresor Mashaka
Seth Sibanda (ZMB)	43					105 (ITA)	Angelo Curcuraci
Mohammed Salih (ENG)	44					106 (BRA)	Fábio Simões
Zohar Kablan (ISR)	45					107 (ARG)	Roberto Mendes
Taha Bahnasi (UAE)	46					108 (SWE)	Jozef Berglez
Matthew Ellem (AUS)	47					109 (RUS)	Marat Sharafiev
Yohan Boudot (FRA)	48					110 (BEL)	Abdelkarim Bouzkik
James Campbell (GBR)	49					111 (CAN)	Hugo DeGroot
Vahagn Vardanyan (ARM)	50					112 (ARM)	Tigran Harutyunyan
Sibongiseni Ngwenya (ZAF)	51					113 (HUN)	Balázs Gyimesi
Cyril Martins (SGP)	52					114 (OMN)	Suqer Alghafri
Daisuke Ueda (JPN)	53					115 (BHR)	Ankur Sharma
Kim Olsson (SWE)	54					116 (MDG)	Toky Rajaonarison
Doru Burdan (ROU)	55					117 (PAK)	Amir Mehboob
Florian Herrmann (DEU)	56					118 (ZMB)	Joseph Kasweka
Tantely Radoniaina (MDG)	57					119 (ROU)	BOGDAN DOLINSCU
Jonathan Mulolo (BEL)	58					120 (JPN)	Keisuke Nemoto
China Metswi (BWA)	59					121 (USA)	Andre Fiallos
Stephen O Connor (IRL)	60					122 (FRA)	Axel Joao
Benjamin Skaatun (NOR)	61					123 (DEU)	Stefan Walsleben
Seiji Saeki (CAN)	62					124 (PAN)	Marco Pazmino



## Women kata

Janette Hansen	(NOR)	1		38	(MEX)	Luicia Becerril
Misaki Matsubara	(JPN)	2		39	(ESP)	Mayra Rios Morales
Jeanette Castañeda	(ARG)	3		40	(BRA)	Leticia Aragão
Crystal Poulter	(ZAF)	4		41	(USA)	Abby Barrera
Paula Giraldo	(COL)	5		42	(ARG)	Vanesa Chaves
Meadhbh O Callghan	(IRL)	6		43	(CZE)	Karin Kosikova
YANG,I-CHENG	(TWN)	7		44	(COL)	Margarita Bustos
Juliana Vitral	(BRA)	8		45	(GBR)	Karolina Marzenta
Rachel O'Halloran	(ENG)	9		46	(ENG)	Roisin Campbell
Marie Prajzlerova	(CZE)	10		47	(AUS)	Sam Sparkes
Cécile Orrigo	(MCO)	11		48	(CAN)	Leah Villanueva
Magali Brachat	(SGP)	12		49	(JPN)	Ayano Nakamura
Anne catherine Novak	(FRA)	13		50	(ITA)	Denise Passerini
Evelyn Naessens	(BEL)	14		51	(SGP)	Naomi Ishibashi
Chane Brits	(AUS)	15		52	(NLD)	Michelle Jongen
Manon Quirion	(CAN)	16		53	(ZAF)	Elsabe Le Roux
Jaclyn Carberry	(GBR)	17		54	(DEU)	Joana Tsesmeles
Jeannette Bellhaeuser	(DEU)	18		55	(FRA)	Marion Guinot
Christina Foo	(USA)	19		56	(PAN)	Delmira Bonilla
Karina Parada	(ARG)	20		57	(HUN)	Kitti Schvarcz
Rose Tumminello	(ENG)	21		58	(USA)	Rachel Kattawar
Marta Tranquillini	(ITA)	22		59	(ARG)	Sofia Siffo
Rio Hayakawa	(JPN)	23		60	(BWA)	Waabo Anwar
Martinna Rey	(BRA)	24		61	(CZE)	Jarmila Masopustova
Sara Elgaard	(DNK)	25		62	(ENG)	Jana Sersnova
Yaremi Borzelli	(PAN)	26		63	(COL)	Clara Martinez
Priscilla Garvey	(ZAF)	27		64	(CHN)	Jing Guo
Lucie Koppelova	(CZE)	28		65	(BRA)	Manuela Spessatto
Melissa Rathmann	(DEU)	29		66	(AUS)	Lana Rosenbaum
Melinda Massotti	(CAN)	30		67	(SWE)	Linda Andersson
Meida Tri Suhartati	(IDN)	31		68	(DEU)	Sara Baradaran
Yadira Suarez	(MEX)	32		69	(ITA)	Tania Cavallera
Monica Masowa	(GBR)	33		70	(CAN)	Pascale Coggins
Lame Hetanang	(BWA)	34		71	(IRL)	Ashley Hill
Ray Semana	(USA)	35		72	(RUS)	Mariia Dauliatshina
Annie Ydström	(SWE)	36		73	(ZAF)	Chanel Stevens
Sherridan Bower	(AUS)	37		74	(JPN)	Yuna Sato





## Women Team kata

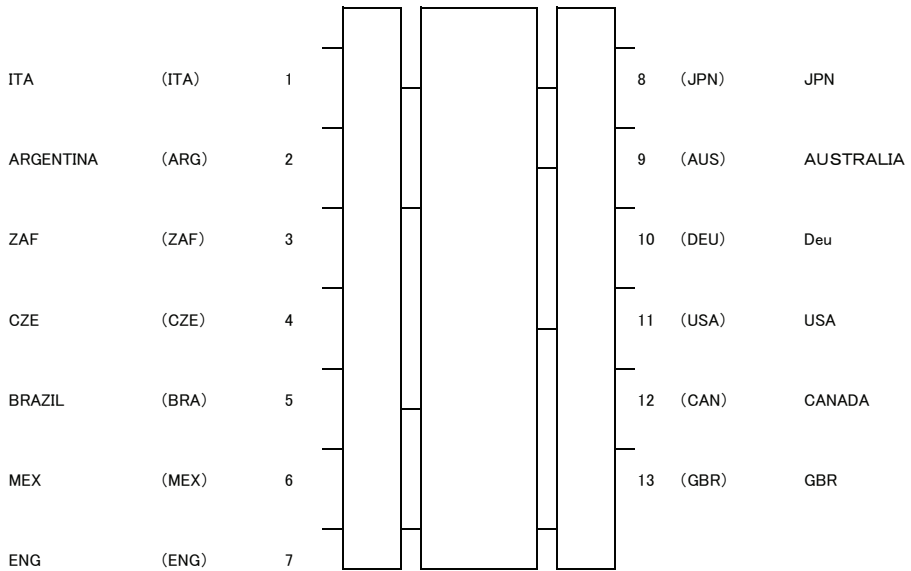

## Women Team Kumite

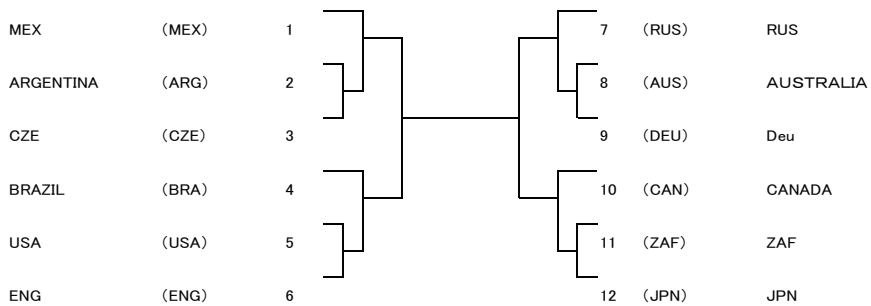

**TUSCANY**  
*Bistro*



*Tuscany at the*  
**GRANARY**  
Tel: 061 468 000  
Email: info@tuscanyle.ie

*Tuscany at*  
**BALLINA**  
Tel: 061 376 888  
Email: info@tuscanyle.ie

*Tuscany at*  
**CASTLETROY**  
Tel: 061 333 444  
Email: info@tuscanyle.ie

*Italian and Mediterranean flavours paired with outstanding cocktails and wine lists*

Tasty Snacks are proud to support  
JKA Ireland and Irish Karate



**KELLEHER TYRES**  
QUALITY & SERVICE

**TYRES  
SERVICING  
BATTERIES  
TRACKING  
BULBS  
AND MORE...**

**WWW.KELLEHERTYRES.IE**



Shihan Afzal Hussain Jafree Sensei Chairman & Founder of JKA  
Islamabad Pakistan Raja Tanveer Ahmed Representative of JKA  
Islamabad Pakistan



# Japan Karate Association Ireland

Noel Casey

Sensei 7<sup>th</sup> Dan

Address: Honbu Dojo, 12a College Commercial Park, Dennehy's Cross, Cork City

Telephone: 00353874133653

Email: [jkairland@hotmail.com](mailto:jkairland@hotmail.com)

社団法人 日本空手協会

[www.jkairland.com](http://www.jkairland.com)

JKA EUROPE

Japan Karate Association World Federation



JKA 日本空手協会アイルランド  
Japan Karate Association Ireland  
The keeper of karate's highest traditions



Supported By

Fáilte Ireland